

Tool Steels Technical Conditions of Delivery		<b>DIN</b> 17 350
Werkzeugstähle; Technische Lieferbedingungen		
<i>For connection with International Standards see Explanations.</i>		
● <i>The sections marked with a dot contain information on possible special agreements.</i>		
<b>1 Scope</b>		
1.1 This Standard applies to		
a) unalloyed cold working steels (see Table 2),	DIN 50 133 Part 1	Testing of metallic materials; Vickers hardness testing; test load range: 49 to 980 N (5 to 100 kp)
b) cold working alloy steels (see Table 3),	DIN 50 192	Determination of the depth of decarburization
c) hot working steels (see Table 4),	DIN 50 351	Testing of metallic materials; Brinell hardness testing
d) high speed steels (see Table 5)		
and to the grades of steel listed in Table 7, which are used predominantly only for one application, in the product forms and as-delivered conditions specified in Sections 6.3 and 8.2.	Handbuch für das Eisenhüttenlaboratorium (Handbook for the Ferrous Metallurgy Laboratory)	Vol. 2: Untersuchung der metallischen Stoffe (The Investigation of Metallic Materials), Verlag Stahleisen mbH, Düsseldorf, 1966 Vol. 5 (Supplement): A 4.1 – Aufstellung empfohlener Schiedsverfahren, B-Probenahmeverfahren, C-Analysenverfahren (A 4.1 – List of recommended arbitration procedures, B-Sampling methods, C-Analytical methods) <sup>1)</sup> , latest edition in each case
1.2 In addition to this Standard, the stipulations in DIN 17 010 (at present still in draft form) apply.		
1.3 Information on the use of tool steels besides being given in Tables 7 and 8 is contained in the following steel application lists <sup>1)</sup> of the Verein Deutscher Eisenhüttenleute (Association of German Ferrous Metallurgy Engineers):		
170 – 73 Steels for tools for the production of bolts, formed parts, rivets and nuts	Stahl-Eisen-Prüfblatt 1520 <sup>1)</sup> (Steel-Iron Test Sheet)	Microscopic testing of carbide formation in steels, using sets of photographs
171 – 72 Steels for tools for plastics processing	Stahl-Eisen-Prüfblatt 1584 <sup>1)</sup> (Steel-Iron Test Sheet)	Blue shortness test for testing steels for macroscopic non-metallic inclusions
185 – 58 Steels for tools for drop forging	Stahl-Eisen-Prüfblatt 1615 <sup>1)</sup> (Steel-Iron Test Sheet)	Microscopic and macroscopic testing of high speed steels for their carbide distribution, using sets of photographs
190 – 58 Steels for dies and die inserts for hot extrusion of non-ferrous metals	Stahl-Eisen-Prüfblatt 1665 <sup>1)</sup> (Steel-Iron Test Sheet)	Testing of the hardenability of high quality steels with hardness fracture specimens
195 – 72 Steels for tools for extrusion of tubes and general extrusion		
198 – 75 Steels for injection moulding dies and highly stressed parts of injection moulding machines		
1.4 ● Even tool steels not listed in Tables 2, 3, 4, 5 or 7 can be ordered and supplied in accordance with this Standard. In this case, the values for the quality properties listed in Tables 2, 3, 4 or 5, should if necessary, be agreed for the steel concerned at the time of ordering.		
<b>2 Other relevant Standards and documents</b>		
DIN 17 010	(at present still in draft form) General technical conditions of delivery for steel and steel products	
DIN 50 049	Certificates on material testing	
DIN 50 103 Part 1	Testing of metallic materials; Rockwell hardness testing, C, A, B, F methods	
	<b>3 Concepts</b>	
	<b>3.1 Tool steels</b> are high quality steels suitable for working or processing of materials and for handling and measuring workpieces. They exhibit a high value of hardness, high resistance to wear and high toughness appropriate to the use for which they are intended.	
	<sup>1)</sup> Verlag Stahleisen mbH, D-4000 Düsseldorf 1	
		Continued on pages 2 to 23 Explanations on pages 23 to 27

**3.2** A distinction is made between the following groups of tool steels:

- a) **Cold working steels:** These are unalloyed or alloy steels for applications in which the surface temperature, when they are used, is generally below about 200 °C.
- b) **Hot working steels:** These are alloy steels for applications in which the surface temperature when they are used is generally over 200 °C.
- c) **High speed steels:** These are steels that, because of their chemical composition, have the highest high-temperature hardness and resistance to temper embrittlement and hence are usable at temperatures up to about 600 °C mainly for machining and also for forming processes.

#### **4 • Dimensions and permissible dimensional deviations**

In the case of strip, sheet and plate, wire, forgings and bars, until specific dimensional Standards are available for such products made of tool steels (at present in preparation) the dimensional Standards listed in Appendix A of this Standard should be used as a basis. However, because of the special features of tool steels, not all the dimensions listed in these Standards can be supplied and not all the permissible deviations given can be maintained. If necessary, the manufacturer should draw the customer's attention to this at the time the order is accepted. Short lengths may be supplied as part of a delivery. Where applicable, agreements should be made at the time of ordering on the permitted percentage of short lengths.

#### **5 Calculation of weight and permissible weight deviation**

**5.1** The following density values should be used as a basis for calculating the nominal weight of products:

For steels with about 18 % W. . . . .	8.7 kg/dm <sup>3</sup> ,
For steels with about 12 % W. . . . .	8.4 kg/dm <sup>3</sup> ,
For steels with about 6 % W. . . . .	8.2 kg/dm <sup>3</sup> ,
For steels with about 3 % W (including steel 60WCrV 7, 1.2550) . . . .	8.0 kg/dm <sup>3</sup> ,
For steels with about 12 % Cr . . . . .	7.6 kg/dm <sup>3</sup> ,
For all other steels. . . . .	7.85 kg/dm <sup>3</sup> .

**5.2** • The permissible weight deviations can be agreed at the time of ordering.

#### **6 Classification of grades, selection of steels and product forms**

##### **6.1 Classification of grades**

The tool steels are classified into the groups listed in Section 1.1.

##### **6.2 Selection of steels**

The selection of steels (see Tables 2, 3, 4, 5 and 7), product form (see Section 6.3) and as-delivered condition (see Section 8.2) is the customer's responsibility.

##### **6.3 Product forms**

The steels according to this Standard are supplied in the form of wire, steel bars (round, square, flat or other cross-section), discs and other shaped parts and as sheet or strip.

#### **7 Designation**

##### **7.1 Grades of steel**

The abbreviations for the grades of steel should be formed in accordance with the explanations to DIN Normenheft 3, 1976 edition, Sections 2.1.2.1 and 2.1.2.2 and the material code numbers in accordance with DIN 17 007 Part 2.

##### **7.2 Order designation**

The code numbers or material number (see Tables 2, 3, 4, 5 and 7) for the grade of steel and the code letter or appended number for the as-delivered condition (see Section 8.2) should be appended to the symbol for the product (see also Section 6.3) as shown in the examples of designation in the dimensional Standards (see also Section 4).

##### **Example:**

Order of 1000 kg of open die-forged round bars made of a steel with the code number X 155 CrVMo 121 or material number 1.2379 in the soft annealed condition (G or .02) of cross-sectional shape A and by forged dimensions (S) in accordance with DIN 7527 Part 6, of diameter  $d = 120$  mm, in manufacturing length:

**1000 kg bars DIN 7527 – X 155 CrVMo 121 G – AS 120 in manufacturing length**

or

**1000 kg bars DIN 7527 – 1.2379.02 – AS 120 in manufacturing length**

#### **8 Requirements**

##### **8.1 Manufacturing process**

**8.1.1** • The smelting process is at the discretion of the manufacturer; it must, however, be disclosed to the customer on request.

**8.1.2** • The choice of the shaping method is at the discretion of the manufacturer except where it is determined by the product form or has been agreed at the time of ordering.

##### **8.2 As-delivered condition**

###### **8.2.1 • Surface condition and machining allowances**

According to the product, tool steels can be ordered and supplied in accordance with various classes as regards the machining allowances, i.e.

- a) with full machining allowance; i.e. in general unmachined;
- b) with restricted machining allowance, i.e. in general pre-machined on all sides;
- c) without machining allowance.

Surface defects and surface decarburization are permissible within the machining allowance.

**Note:** Until the Standard on machining allowance classes at present in preparation has been issued, the necessary agreements should be made at the time of ordering.



**8.2.2 • Heat treatment condition**

With the exception of the steels C 45 W (see Table 2) and 40 CrMnMoS 8 6 (see Table 3) the steels in this Standard, unless otherwise agreed at the time of ordering, are supplied in the soft-annealed condition (G or .02).

**8.3 Chemical composition**

**8.3.1** The chemical composition in the ladle analysis is specified for the steels dealt with in this Standard in Tables 2, 3, 4, 5 and 7. Slight deviations are permitted provided the requirements given in Section 8.4 are complied with and that there is no harmful effect on the properties of the steel in use and the workability.

**8.3.2 •** For the product analyses of the steels in accordance with Tables 2, 3, 4 and 5, in the case of products up to 160 mm diameter or equivalent dimensions, the permissible deviations specified in Table 6 apply in comparison with the limits specified in Tables 2, 3, 4 and 5 for the ladle analysis. For products of larger dimensions, where applicable, the permissible deviations should be agreed at the time of ordering.

**8.4 Mechanical properties**

The steels in Tables 2, 3, 4 and 5 must comply with the values given in these tables for the soft annealed or hardened and tempered condition.

**8.5 Surface condition and internal defects**

**8.5.1** All products must have a surface appropriate to the manufacturing process (see Section 8.2.1).

**8.5.2 •** The steel must be free from internal defects such as pores, cracks, blowholes and macroscopic non-metallic inclusions that could have a significant effect on workability and usability.

Any special requirements regarding the internal condition should, if necessary, be agreed at the time of ordering.

**8.6 Condition of structure**

For the "soft annealed" heat treatment condition which is the normal one generally supplied in accordance with Tables 2, 3, 4 and 5 (except in the case of steel C 45 W [1.1730] in Table 2 and 40 CrMnMoS 8 6 [1.2312] in Table 3) the structural conditions listed in Sections 8.6.1 to 8.6.4 are the most likely to occur.

**8.6.1** In the case of unalloyed cold working steels as given in Table 2, the structure consists of ferrite and carbides.

**8.6.2** In the case of cold working alloy steels as listed in Table 3, with the exception of steels with  $\approx 12\%$  Cr, the structure consists of ferrite and carbides. The carbides shall, if possible, not be concentrated at the grain boundaries. Cold working steels with  $\approx 12\%$  Cr also contain a larger proportion of eutectic carbides. They are arranged in lines or in a network according to the degree of deformation. Their magnitude is determined by the size of blank used and the degree of forming necessitated by the final dimensions.

**8.6.3 •** Hot working steels (see Table 4) have a structure consisting of ferrite and carbides. In the case of large dimensions in particular, zones with segregations are permitted, provided the properties of the steel

in use are not significantly affected by this. The carbides shall, if possible, not be concentrated at the grain boundaries.

If necessary, special agreements on the structural condition may be made at the time of ordering.

**8.6.4 •** The structure of high speed steels (see Table 5) consists of ferrite, eutectic carbides and secondary carbides. The carbide diameters are affected by the size of blank used and the processing conditions. In the case of thicker dimensions, larger eutectic carbides are likely to occur. High speed steels with high vanadium and tungsten content have larger carbides. The eutectic carbides are arranged in lines or in a network according to the degree of forming used.

When assessing the carbide distribution in accordance with the guidelines in Stahl-Eisen-Prüfblatt 1615<sup>1)</sup> stage C may occur for the dimension range concerned in isolated cases within a delivery.

If in special cases more stringent requirements are necessary, these have to be agreed at the time of ordering.

**9 Heat treatment**

**9.1** For approximate values for heat treatment of tool steels and the associated hardness/annealing temperature curves see Tables 2, 3, 4 and 5 and Figs 1, 2, 3 and 4.

**9.2** Supplementary data for heat treatment including time/temperature-transformation diagrams for steels as listed in Tables 2, 3, 4 and 5 and approximate values for the effect of the workpiece diameter on the core hardness and case hardening depth of cold working alloy steels and on the dependence of the mechanical properties on the test temperature of hot working steels are given in Supplement 1 to DIN 17 350.

**10 Testing****10.1 • Acceptance test**

The customer may agree acceptance tests for the requirements concerned in accordance with Section 8 at the time of ordering. Such acceptance tests are generally carried out by the supplier's inspectors, but by special agreement at the time of ordering they may also be carried out by outside inspectors acting for the customer. Unless otherwise agreed, the stipulations of Sections 10.2 to 10.6 apply to acceptance testing. Even if no acceptance tests have been agreed, the delivery must comply with the requirements of Section 8.

**10.2 Extent of testing**

**10.2.1** The stipulations in Sections 10.2.1.1 to 10.2.1.4 apply to all products.

**10.2.1.1 • Chemical composition**

If proof of the chemical composition in a product analysis has been agreed at the time of ordering but no stipulation has been made as to the extent of testing, one specimen shall be taken per melt.

<sup>1)</sup> See page 1



**10.2.1.2 Mechanical properties**

**10.2.1.2.1** One test piece per melt, per heat treatment batch and per dimension of the product shall be taken for testing compliance with the stipulated hardness values in the soft annealed condition. If the differences in dimension are only slight (a thickness ratio of about  $\leq 1.5$ ) there is no need to test the products separately by size.

If heat treatment is carried out in a continuous process, one test piece shall be taken per 10 t, but at least one test piece per melt and per dimension range.

**10.2.1.2.2** One test piece per 10 t shall be taken for testing the hardness values in the tempered condition, but at least one test piece per melt.

**10.2.1.3 • Surface condition**

If the customer requires retesting of the surface condition or the surface decarburization, the extent of such testing shall be agreed at the time of ordering.

**10.2.1.4 Internal condition**

**10.2.1.4.1 • A macroscopic inspection** of the products for non-metallic inclusions may be agreed at the time of ordering, the extent of the inspection being agreed at the same time.

A microscopic examination for non-metallic inclusions is only carried out in special cases for tool steels.

**10.2.1.4.2 • If the customer requires examination** of the structure of the products, the extent of such examination should also be agreed at the time of ordering.

**10.3 Sampling and preparation of specimens**

**10.3.1** For testing the chemical composition of the product, chips should be taken uniformly over the complete cross-section of the product being tested. If this is not feasible, the chips should be taken at suitable places characteristic of the complete cross-section.

If the spectral analysis method is used, the test may be carried out at the surface of the product; in cases of doubt, however, a number of analyses must be made across the cross-section and the average of the results taken.

**10.3.2** For hardness testing in the as-delivered condition, the surface of the test piece or a specimen taken from the test piece in the as-delivered condition shall be prepared in accordance with DIN 50 351 or DIN 50 133 Part 1.

**10.3.3** For testing the hardness in the tempered condition, a specimen shall be taken from the test piece in accordance with the conditions given in Fig. 5. The specimens shall be hardened and tempered under the conditions given in Tables 2, 3, 4 and 5, taking the necessary precautions to prevent decarburization.

During the complete heating period (residence time) in a salt bath, the values given in Table 1 apply.

1) See page 1

2) Handbuch für das Eisenhüttenlaboratorium (Handbook for the Ferrous Metallurgy Laboratory), Vol. 2 and Vol. 5 (Supplement), (see Section 2).

Table 1.

Specimens made of	Residence time for hardening min	Tempering time min
Cold working or hot working steels (see Tables 2, 3 and 4)	25 ± 1 (see also Supplement 1 to DIN 17 350)	60
High speed steel (see Table 5)	3 (see also Supplement 1 to DIN 17 350)	at least 2 x 60

If the specimens are not heated in a salt bath, the heating period shall be appropriately increased.

The cut surface shall be prepared in accordance with DIN 50 103 Part 1 for Rockwell C hardness testing or, in the case of high speed steels, if necessary, in accordance with DIN 50 133 Part 1 for Vickers hardness testing.

**10.3.4** For testing for surface decarburization, the sampling procedure and preparation of specimens are as given in DIN 50 192.

**10.3.5** Sampling for macroscopic testing for non-metallic inclusions is as given in Stahl-Eisen-Prüfblatt 1584<sup>1)</sup>.

**10.3.6** For investigating the structure of high speed steels, samples are taken in accordance with Stahl-Eisen-Prüfblatt 1615<sup>1)</sup>. For investigating the structure of cold working and hot working steels, sampling shall be as appropriate.

**10.4 Test procedure**

**10.4.1** The chemical composition shall be tested in accordance with the method specified by the Chemists' Committee of the Verein Deutscher Eisenhüttenleute (Association of German Ferrous Metallurgy Engineers)<sup>2)</sup>.

**10.4.2** The hardness tests are carried out in accordance with DIN 50 103 Part 1 for Rockwell C hardness, DIN 50 133 Part 1 for Vickers hardness and DIN 50 351 for Brinell hardness.

**10.4.3** The depth of surface defects is measured by grinding out, filing down, by electrical or magnetic test methods or metallographically on a polished section.

If a test of surface decarburization is required, this should be carried out using one of the methods given in DIN 50 192 or alternatively, in the case of high speed steels, using the so-called colour ring etching method. In cases of doubt, the carbon content shall be determined on turned-down specimens.

**10.4.4** Macroscopic testing for non-metallic inclusions is carried out on blue shortness specimens in accordance with Stahl-Eisen-Prüfblatt 1584<sup>1)</sup>.

**10.4.5** The structure is examined microscopically in accordance with Stahl-Eisen-Prüfblatt 1520<sup>1)</sup>. By this

means the size and distribution of the austenite and ferrite grains and of the carbides can be determined. Determination of the distribution of the eutectic carbides in high speed steels is carried out in accordance with Stahl-Eisen-Prüfblatt 1615<sup>1)</sup>.

### 10.5 Repeat tests

10.5.1 For all products, the stipulations in Sections 10.5.1.1 to 10.5.1.3 apply.

10.5.1.1 If an unsatisfactory result in a test is attributable to one strictly limited defect, this result shall be ignored in deciding whether the requirements have been complied with and a substitute specimen tested.

10.5.1.2 If an unsatisfactory result in a test is attributable to improper heat treatment, the heat treatment may be carried out again and the complete test shall then be repeated.

10.5.1.3 If the test results of individual specimens fail to meet the stipulated requirements for other reasons than those given in Sections 10.5.1.1 and 10.5.1.2, two replacement specimens from another test piece should be tested for each specimen that fails. Only if both these specimens meet the requirements will the test unit concerned be regarded as meeting the conditions.

### 10.6 Test certificates

10.6.1 • The customer may agree at the time of ordering on one of the certificates in accordance with DIN 50 049.

10.6.1.1 • A works certificate is sufficient for certifying that the heat treatment has been carried out as ordered.

10.6.1.2 • A works certificate must be agreed for reporting the result of a ladle analysis.

10.6.1.3 • An acceptance test certificate or an acceptance test report should be agreed for reporting the result of a hardness test.

10.6.1.4 • Certificates on other tests can be agreed at the time of ordering.

## 11 Marking, packaging and despatch

11.1 • Coils of wire up to 30 mm wire diameter or equivalent cross-sections of strip, sheet or shaped material and also bars are bundled and labelled. The marking contains data on the supplier, order number, melt number, grade of steel, dimensions and coil weight. Larger dimensions and separate pieces shall either be separately lettered with paint or stamped. The extent of the marking should be agreed at the time of ordering (see also DIN 1599).

11.2 Steel bars with ground or polished surface are lightly greased to protect the surface. This surface protection, however, will not prevent the surface starting to rust after a lengthy period of storage or under unsatisfactory storage conditions.

11.3 The packaging must be such that the bars are not damaged by bending during transport.

## 12 Complaints<sup>3)</sup>

12.1 Objections may only be raised to external or internal defects if they impair to an appreciable extent appropriate working and utilization of the grade of steel and shape of product.

12.2 The customer must give the supplier the opportunity to check for himself the validity of the complaints, where possible, by submitting the material complained of together with samples of the material supplied.

<sup>1)</sup> See page 1

<sup>3)</sup> For explanations on this complaints clause in Quality Standards for Iron and Steel see DIN-Mitt. 40 (1961), No. 2, pp. 111-112.

Table 2. Chemical composition (ladle analysis), data for heat treatment, hardenability characteristics and hardness in the soft-annealed condition and in the hardened and tempered condition for unalloyed cold working steels

Grade of steel	Code number	Material No.	Chemical composition % by weight					Hardness in the soft-annealed condition 1)	Approximate values for hardening and hardenability characteristics					Hardness after tempering 5)			
			C	Si	Mn	P max.	S max.		Temperature °C	Hardness medium 3)	Hardness penetration depth for 30 mm vkt 4)	Full-hardened diameter mm	Tempering temperature °C	Hardness after tempering HRC	Hardness after tempering °C	Hardness after tempering HRC max.	
C 45 W	1.1730	0.40 to 0.50	0.15 to 0.40	0.60 to 0.80	0.035	0.035	0.035	HB 2) max.	is normally supplied without special heat treatment with a hardness of about 190 HB					810	O	180	52
C 60 W	1.1740	0.55 to 0.65	0.15 to 0.40	0.60 to 0.80	0.035	0.035	0.035	231	800 to 830	O	3.5	12	810	O	180	52	
C 70 W2	1.1620	0.65 to 0.74	0.10 to 0.30	0.10 to 0.35	0.030	0.030	183	790 to 820	W	3.0	10	800	W	180	57		
C 80 W1	1.1525	0.75 to 0.85	0.10 to 0.25	0.10 to 0.25	0.020	0.020	192	780 to 810	W	2.5	10	790	W	180	59		
C 85 W	1.1830	0.80 to 0.90	0.25 to 0.40	0.50 to 0.70	0.025	0.020	222	800 to 830	O	4.5	12 6)	810	O	180	57		
C 105 W1	1.1545	1.00 to 1.10	0.10 to 0.25	0.10 to 0.25	0.020	0.020	213	770 to 800	W	2.5	10	780	W	180	60		

1) In the case of products involving follow-up cold drawing or skin-pass cold rolling, values up to 20 HB higher are likely to occur.  
 2) For small dimensions, the Vickers hardness may be determined. In this case, the Vickers hardness values determined have to be converted into Brinell hardness values in accordance with DIN 50 150.  
 3) Quenching media O = oil, W = water.  
 4) The values apply to visual inspection in accordance with Stahl-Eisen-Prüfblatt 1 665.  
 5) See Section 10.3.3 and Fig. 5.  
 6) In the case of sheet up to a thickness of about 8 mm, the material is likely to assume a uniform hardness across the cross-section and the surface.



Table 3. Chemical composition (ladle analysis), data for heat treatment and hardness in the soft-annealed condition and in the hardened + tempered condition for cold working alloy steels

Grade of steel		Chemical composition 1)										Hardness in the soft-annealed condition 2)		Approximate values for Hardness				Hardness after tempering 5)	
Code number	Material No.	C	Si	Mn	Cr	Mo	Ni	V	W	HB 3) max.	Temper-ature °C	medium 4)	Temper-ature °C	Hard-ness after temper-ature °C	HCR mfr.				
X 210 Cr-W 12	1.2436	2.00 to 2.25	0.10 to 0.40	0.15 to 0.45	11.00 to 12.00	-	-	-	0.60 to 0.80	255	950 to 980	O, Wb, L	960	O	180	60			
(X 210 Cr 12) 6)	(1.2080) 6)	1.90 to 2.20	0.10 to 0.40	0.15 to 0.45	11.00 to 12.00	-	-	-	-	248	940 to 970	O, Wb	960	O	180	60			
(X 165 Cr-Mo-V 12) 9)	(1.2650) 1) 6)	1.55 to 1.75	0.25 to 0.40	0.20 to 0.40	11.00 to 12.00	0.50 to 0.70	-	0.10 to 0.50	0.40 to 0.60	255	980 to 1010	O, L, Wb	1000 7)	L	180	60 7)			
X 155 Cr-V-Mo 12 1	1.2379	1.50 to 1.60	0.10 to 0.40	0.15 to 0.45	11.00 to 12.00	0.60 to 0.80	-	0.90 to 1.10	-	255	1020 to 1050 8)	O, Wb, L	1030	O	180	59			
115 Cr-V 3	1.2210	1.10 to 1.25	0.15 to 0.30	0.20 to 0.40	0.50 to 0.80	-	-	0.07 to 0.12	-	223	(760 to 810 810 to 840	W O (<12mm)	790	W	180	60			
100 Cr 6	1.2067	0.95 to 1.10	0.15 to 0.35	0.25 to 0.45	1.35 to 1.65	-	-	-	-	223	820 to 850	O	840	O	180	60			
145 V 33	1.2838	1.40 to 1.50	0.20 to 0.35	0.30 to 0.50	-	-	-	3.00 to 3.50	-	229	800 to 950 9)	W	850	W	180	60			
21 MnCr 5	1.2162	0.18 to 0.24	0.15 to 0.35	1.10 to 1.40	1.00 to 1.30	-	-	-	-	212	810 to 840	O	820	O	180	58 10)			
90 MnCr-V 8	1.2842	0.85 to 0.95	0.10 to 0.40	1.90 to 2.10	0.20 to 0.50	-	-	0.05 to 0.15	-	229	790 to 820	O	800	O	180	58			
105 WCr 6	1.2419	1.00 to 1.10	0.10 to 0.40	0.80 to 1.10	0.90 to 1.10	-	-	-	1.00 to 1.30	229	800 to 830	O	820	O	180	59			
60 WCr-V 7	1.2550	0.55 to 0.65	0.50 to 0.70	0.15 to 0.45	0.90 to 1.20	-	-	0.10 to 0.20	1.80 to 2.10	228	870 to 900	O	890	O	180	57			
X 45 NiCr-Mo 4	1.2757	0.40 to 0.50	0.10 to 0.40	0.15 to 0.45	1.20 to 1.50	0.15 to 0.35 11)	3.80 to 4.30	-	-	262	840 to 870	O	850	O	180	52			
X 19 NiCr-Mo 4	1.2764	0.16 to 0.22	0.10 to 0.40	0.15 to 0.45	1.10 to 1.40	0.15 to 0.25 12)	3.80 to 4.30	-	-	255	(780 to 810 1800 to 830	O L	800	O	180	59 10)			
X 36 Cr-Mo 17	1.2316	0.33 to 0.43	max. 1.00	max. 1.00	15.00 to 17.00	1.00 to 1.30	max. 1.00	-	-	285	1000 to 1040	O	1010	O	180	46			
40 Cr-Mn-Mo-S 8 6 13)	1.2312 13)	0.35 to 0.45	0.30 to 0.50	1.40 to 1.60	1.80 to 2.00	0.15 to 0.25	-	-	-	-	-	-	-	-	-	-			

1) For all steels the values ≤ 0.030% P and ≤ 0.030% S apply (see footnote 13, however).  
 2) In the case of products involving follow-up cold drawing or sk-in-pass cold rolling, values about 20 HB higher are likely to occur.  
 3) For small dimensions, the Vickers hardness may be determined. In this case, the Vickers hardness values determined have to be converted into Brinell hardness values in accordance with DIN 50 150.  
 4) Quenching media O = oil, L = air, W = water, Wb = hot bath.  
 5) See Section 10.3.3 and Fig. 5.  
 6) This steel will probably no longer be contained in a later issue of this Standard (see Explanations).  
 7) Because of the danger of twisting, a lower hardening temperature and hence also a lower hardness value is specified than for the comparable grade in EU 96.  
 8) If nitriding is carried out after hardening and tempering and, if it is required that the hardness should not fall too sharply, hardening temperatures of 1050 to 1080 °C are recommended.  
 9) The hardness penetration depth is controllable over a wide range by the hardening temperature.  
 10) Surface hardness after case hardening; the hardening temperature refers to the carburized surface layer.  
 11) The molybdenum addition may be replaced by addition of 0.40 to 0.60% of tungsten.  
 12) The molybdenum addition may be replaced by addition of 0.30 to 0.50% of tungsten.  
 13) 0.05 to 0.10% S.

Table 4. Chemical composition (ladle analysis), data for heat treatment and hardness in the soft-annealed or hardened + tempered condition for hot working steels

Grade of steel		Chemical composition 1)										Hardness in the soft-annealed condition 2)		Approximate values for			Hardness after tempering 5)		
Code number	Material No.	C	Si	Mn	Cr	Mo	Ni	V	Hardness medium 4)		Temperature °C	Hardness after tempering HRC	Temperature °C	Hardness medium 4)	Temperature °C	Hardness after tempering HRC min.			
55 NiCrMo V 6	1.2713	0.50 to 0.60	0.10 to 0.40	0.65 to 0.95	0.60 to 0.80	0.25 to 0.35	1.50 to 1.80	0.07 to 0.12	0.07 to 0.12	830 to 870	870	850	850	O	500	40			
56 NiCrMo V 7	1.2714	0.50 to 0.60	0.10 to 0.40	0.65 to 0.95	1.00 to 1.20	0.45 to 0.55	1.50 to 1.80	0.07 to 0.12	0.07 to 0.12	830 to 870 1860 to 900	O L	850	850	O	500	44			
X 38 CrMo V 5 1	1.2343	0.36 to 0.42	0.90 to 1.20	0.30 to 0.50	4.80 to 5.50	1.10 to 1.40	-	0.25 to 0.50	-	1000 to 1040	O, L, Wb	1020	1020	O	550	50			
X 40 CrMo V 5 1	1.2344	0.37 to 0.43	0.90 to 1.20	0.30 to 0.50	4.80 to 5.50	1.20 to 1.50	-	0.90 to 1.10	-	1020 to 1060	O, L, Wb	1030	1030	O	550	51			
X 32 CrMo V 3 3	1.2365	0.28 to 0.35	0.10 to 0.40	0.15 to 0.45	2.70 to 3.20	2.60 to 3.00	-	0.40 to 0.70	-	1010 to 1050	O, Wb	1040	1040	O	550	47			

1) For all steels the values ≤ 0.030 % P and ≤ 0.030 % S apply.  
 2) In the case of products involving follow-up cold drawing or skin-pass cold rolling, values up to 20 HB higher are likely to occur.  
 3) For small dimensions, the Vickers hardness may be determined. In this case, the Vickers hardness values determined have to be converted into Brinell hardness values in accordance with DIN 50 150.  
 4) Quenching media O = oil, L = air, Wb = hot bath.  
 5) See Section 10.3.3 and Fig. 5.



Table 5. Chemical composition (ladle analysis), data for heat treatment and hardness in the soft-annealed or hardened + tempered condition for high speed steels

Grade of steel		Chemical composition 1)										Hardness in the soft-annealed condition 2)	Approximate values for			Hardness after tempering 6)		
Code number	Material No.	C	Co	Cr	Mo	V	W	Hardness medium 4)	Temper-ature °C	Hard-ness after temper-ature °C	Hardness medium 4), 5)		Temper-ature °C	Hardness after tempering				
S 6-5-2 8)	1.3343 8)	0.86 to 0.94	-	3.80 to 4.50	4.70 to 5.20	1.70 to 2.00	6.00 to 6.70	O, Wb, L	1190 to 1230	HRC	O, Wb	560	(850)					
SC 6-5-2 8)	1.3342 8)	0.95 to 1.05	-	3.80 to 4.50	4.70 to 5.20	1.70 to 2.00	6.00 to 6.70	O, Wb, L	1180 to 1220	HRC	O, Wb	560	(880)					
S 6-5-3	1.3344	1.17 to 1.27	-	3.80 to 4.50	4.70 to 5.20	2.70 to 3.20	6.00 to 6.70	O, Wb, L	1200 to 1240	HRC	O, Wb	560	(880)					
S 6-5-2-5 8)	1.3243 8)	0.88 to 0.96	4.50 to 5.00	3.80 to 4.50	4.70 to 5.20	1.70 to 2.00	6.00 to 6.70	O, Wb, L	1200 to 1240	HRC	O, Wb	560	(850)					
S 7-4-2-5	1.3246	1.05 to 1.15	4.80 to 5.20	3.80 to 4.50	3.80 to 4.00	1.70 to 1.90	6.60 to 7.10	O, Wb, L	1180 to 1220	HRC	O, Wb	540	(910)					
S 10-4-3-10	1.3207	1.20 to 1.35	9.50 to 10.50	3.80 to 4.50	3.20 to 3.90	3.00 to 3.50	9.00 to 10.00	O, Wb, L	1210 to 1250	HRC	O, Wb	560	(910)					
S 12-1-4-5	1.3202	1.30 to 1.45	4.50 to 5.00	3.80 to 4.50	0.70 to 1.00	3.50 to 4.00	11.50 to 12.50	O, Wb, L	1210 to 1250	HRC	O, Wb	560	(880)					
S 18-1-2-5	1.3255	0.75 to 0.83	4.50 to 5.00	3.80 to 4.50	0.50 to 0.80	1.40 to 1.70	17.50 to 18.50	O, Wb, L	1250 to 1300	HRC	O, Wb	550	(850)					
(S 2-10-1-8) 9)	(1.3247) 9)	1.05 to 1.12	7.50 to 8.50	3.60 to 4.40	9.00 to 10.00	1.00 to 1.30	1.20 to 1.80	O, Wb, L	1170 to 1210	HRC	O, Wb	540	(910)					

1) For all steels the values  $\leq 0.45\%$  Si,  $\leq 0.40\%$  Mn,  $\leq 0.030\%$  P and  $\leq 0.030\%$  S (see also footnote 8) apply.  
 2) In the case of products involving follow-up cold drawing or skin-pass cold rolling, values of up to 320 HB are likely to occur.  
 3) For small dimensions, the Vickers hardness can be determined. In this case, the Vickers hardness values determined have to be converted into Brinell hardness values in accordance with DIN 50 150.  
 4) Quenching media O = oil, Wb = hot bath, L = air.  
 5) In arbitration cases, hot bath.  
 6) See Section 10.3.3 and Fig. 5.  
 7) These are empirically determined values comparable with the minimum values for Rockwell C hardness testing.  
 8) Under the designations S 6-5-2 S (1.3341), SC 6-5-2 S (1.3245) and S 6-5-2-5 S (1.3246) these steels also exist with 0.06 to 0.15% S, the chemical composition being otherwise the same.  
 9) This steel will probably no longer be contained in a later issue of this Standard (see Explanations).

Table 6. Permissible deviations in product analyses from the limits given in Tables 2 to 5 for the ladle analysis

Element	Permissible maximum content in the ladle analysis	Permissible deviation of the product analysis from the limits given for the ladle analysis <sup>1)</sup>
C	$\leq 1.00$	$\pm 0.03$
	$> 1.00 \leq 1.50$	$\pm 0.04$
	$> 1.50 \leq 2.25$	$\pm 0.05$
Si	$\leq 1.00$	$\pm 0.03$
	$> 1.00 \leq 1.20$	$\pm 0.05$
Mn	$\leq 1.00$	$\pm 0.04$
	$> 1.00 \leq 2.10$	$\pm 0.08$
P	$\leq 0.035$	+0.005 0
S	$\leq 0.05$	+0.005 0
	$> 0.05 \leq 0.15$	$\pm 0.01$
Co	$\leq 5.00$	$\pm 0.10$
	$> 5.00 \leq 10.50$	$\pm 0.15$
Cr	$\leq 1.00$	$\pm 0.05$
	$> 1.00 \leq 3.00$	$\pm 0.07$
	$> 3.00 \leq 10.00$	$\pm 0.10$
	$> 10.00 \leq 17.00$	$\pm 0.15$
Mo	$\leq 0.50$	$\pm 0.04$
	$> 0.50 \leq 1.00$	$\pm 0.05$
	$> 1.00 \leq 10.00$	$\pm 0.10$
V	$\leq 0.30$	$\pm 0.02$
	$> 0.30 \leq 0.50$	$\pm 0.04$
	$> 0.50 \leq 1.00$	$\pm 0.07$
	$> 1.00 \leq 4.00$	$\pm 0.10$
W	$\leq 1.00$	$\pm 0.05$
	$> 1.00 \leq 2.00$	$\pm 0.07$
	$> 2.00 \leq 5.00$	$\pm 0.10$
	$> 5.00 \leq 10.00$	$\pm 0.15$
	$> 10.00 \leq 18.50$	$\pm 0.20$

<sup>1)</sup> In any one melt, the values for an element in the case of several product analyses may either be only above the upper limit or only below the lower limit of the range applying to the ladle analysis.



Table 7. Chemical composition (ladle analysis) and use of tool steels for special applications

Grade of steel		Chemical composition 1) in % by weight										Intended application
Code number	Material No.	C	Si	Mn	Cr	Mo	V	W				
75 Cr 1	1.2003	0.70 to 0.80	0.25 to 0.50	0.60 to 0.80	0.30 to 0.40	—	—	—				Band saws and circular saws
62 SiMnCr 4	1.2101	0.58 to 0.66	0.90 to 1.20	0.90 to 1.20	0.40 to 0.70	—	—	—				Guillotine blades
31 CrV 3	1.2208	0.28 to 0.35	0.25 to 0.40	0.40 to 0.60	0.40 to 0.70	—	0.07 to 0.12	—				Bolt and screw dies
80 CrV 2	1.2235	0.75 to 0.85	0.25 to 0.40	0.30 to 0.50	0.40 to 0.70	—	0.15 to 0.25	—				Band saws, circular saws, saws and machine blades
51 CrV 4	1.2241	0.47 to 0.55	0.15 to 0.35	0.80 to 1.10	0.90 to 1.20	—	0.10 to 0.20	—				Bolt and screw dies
48 CrMoV 6 7	1.2323	0.40 to 0.50	0.15 to 0.35	0.60 to 0.90	1.30 to 1.60	0.65 to 0.85	0.25 to 0.35	—				Extruding tools
45 CrMoV 7	1.2328	0.42 to 0.47	0.20 to 0.30	0.85 to 1.00	1.70 to 1.90	0.25 to 0.30	approx. 0.05	—				Chisels
X 96 CrMoV 12	1.2376	0.92 to 1.00	0.20 to 0.40	0.20 to 0.40	11.00 to 12.00	0.80 to 1.00	0.80 to 1.00	—				Guillotine blades
110 WCrV 5 2)	1.2519 2)	1.05 to 1.15	0.15 to 0.30	0.20 to 0.40	1.10 to 1.30	—	0.15 to 0.25	1.20 to 1.40				Cutting tools for paper industry
60 MnSiCr 4	1.2826	0.58 to 0.65	0.80 to 1.00	0.80 to 1.20	0.20 to 0.40	—	—	—				Clamping devices
S 3-3-2	1.3333	0.95 to 1.03	max. 0.45	max. 0.40	3.80 to 4.50	2.50 to 2.80	2.20 to 2.50	2.70 to 3.00				Metal saws
S 2-9-2 3)	1.3348 3)	0.97 to 1.07	max. 0.45	max. 0.40	3.50 to 4.20	8.00 to 9.20	1.80 to 2.20	1.50 to 2.00				Thread cutters

1) For all steels the values  $\leq 0.030\%$  P and  $\leq 0.030\%$  S apply.

2) This steel has been provisionally adopted and will probably be replaced by steel 105WCr 6 (1.2419) from Table 3.

3) This steel has been provisionally adopted (see Explanations).

Table 8. Particularly characteristic possible applications for tool steels in accordance with Tables 2, 3, 4 and 5

Steel group	Grade of steel		Principal application
	Code number	Material No.	
Unalloyed cold working steels in accordance with Table 2	C 45 W	1.1730	Hand tools and agricultural implements of all kinds, assembling parts for tools, tongs.
	C 60 W	1.1740	Hand tools and agricultural implements of all kinds, shafts and bodies of high speed steel or carbide compound tools unhardened hot sawing blades, assembling parts for tools.
	C 70 W 2	1.1620	Inserted tools in compressed air devices for mining and road construction.
	C 80 W 1	1.1525	Dies with shallow impressions, cold heading dies, knives, hand chisels, chisel points.
	C 85 W	1.1830	Frame saws and circular saws and also band saws for wood processing, handsaws for forestry, mowing machine blades.
	C 105 W 1	1.1545	Fast cutting tools, cold heading dies, extruding and embossing tools, gauge blocks.
Cold working alloy steels in accordance with Table 3	X 210 CrW 12	1.2436	Cutting tools, guillotine blades for cutting steel sheet up to about 3 mm thick and for cutting hardened steel strip, broaches, highly stressed woodworking tools where the toughness requirement is not too high, shaping and flanging tools, blades for producing chopped wire, thread rolling tools, deep drawing tools, press tools for the ceramic and pharmaceutical industry, drawing cones for wire drawing, extruding tools and guide strips, sand blasting nozzles.
	X 210 Cr 12	1.2080	Same applications as steel 1.2436 with reduced hardenability.
	X 165 CrMoV 12	1.2601	Same applications as steel 1.2379.
	X 155 CrVMo 12 1	1.2379	Dimensionally stable high performance cutting steel, fracture-sensitive cutting dies, metal saws, press trimmers, bending dies, guillotine blades for a sheet thickness up to 6 mm, cold shearing blades, flash trimming dies, thread rolling tools, highly stressed woodworking tools, hobbing tools, extruding tools. Generally: Applications similar to those of steels 1.2436 and 1.2080 with higher requirements regarding toughness.
	115 CrV 3	1.2210	Taps, ejectors, punches, countersinks, gear cutters, mortice chisels, ejecting rams (preferably used in the form of bright drawn carbon tool steel).
	100 Cr 6	1.2067	Gauges, mandrels, cold rolls, woodworking tools, flanging rolls, punches, tube-forming mandrels, drawing mandrels.
	145 V 33	1.2838	Cold heading tools with high abrasion resistance, press trimming tools.
	21 MnCr 5	1.2162	Tools for plastics processing that can be machined and case-hardened.
	90 MnCrV 8	1.2842	Punches, cutters, deep drawing tools, cutting tools, moulds for plastics, clipping beds and punches, industrial knives, measuring tools.



Table 8. (Continued)

Steel group	Grade of steel		Principal application
	Code number	Material No.	
Cold working alloy steels in accordance with Table 3	105 WCr 6	1.2419	Thread-cutting dies, milling cutters, reamers, gauges, clipping beds and punches, precision mould cutters, woodworking tools, small plastic moulds, test mandrels, paper cutting blades, measuring tools, thread chases, cutting faces, slide calliper jaws.
	60 WCrV 7	1.2550	Shears for thicker metal (for steel plates from 6 to 15 mm), circular and longitudinal shear blades, punches for cold punching of rails and sheet, woodworking tools, industrial knives, teeth for chain saws, coining tools, flash trimming dies, cold punching and upsetting tools, ejectors.
	X 45 NiCrMo 4	1.2767	Highly stressed coining tools with maximum toughness, tools for heavy cold-forming, highly stressed blanking dies, dies for jewellery, hobbing tools, shear blades for the thickest cutting material.
	X 19 NiCrMo 4	1.2764	Air-hardening, case-hardening steels for plastic moulds.
	X 36 CrMo 17	1.2316	Tools for processing chemically corrosive thermoplastics.
	X 40 CrMnMoS 8 6	1.2312	Tools for plastics processing, chases.
Hot working steels in accordance with Table 4	55 NiCrMoV 6	1.2713	Hammer forging dies for medium and small dimensions.
	56 NiCrMoV 7	1.2714	Hammer forging dies up to the largest dimensions, particularly also with heavy embossing; part dies, die holders, plungers for extrusion presses.
	X 38 CrMoV 5 1	1.2343	Dies and die inserts, tools for forging machines; pressure casting dies for light metals; highly stressed tools for extrusion of light metals such as liners, dies, punches.
	X 40 CrMoV 5 1	1.2344	Dies and die inserts, tools for forging machines; pressure casting dies for light metals; highly stressed tools for extrusion of light metals, particularly mandrels for extrusion of tubes, part dies.
	X 32 CrMoV 3 3	1.2365	Die inserts, tools for the manufacture of nuts, bolts and rivets, tools for forging machines, highly stressed tools for extrusion of copper alloys (liners, dies) and of light metal (bolsters, mandrels); pressure casting dies for brass and light metal.
High speed steels in accordance with Table 5	S 6-5-2	1.3343	Broaches, twist drills, milling cutters, reamers, taps, countersinks, planing tools, circular saws, forming tools, cutting and fine cutting tools, hobbing tools.
	SC 6-5-2	1.3342	Broaches, twist drills, milling cutters, reamers, taps, countersinks, forming tools, cutting and fine cutting tools.
	S 6-5-3	1.3344	Taps and reamers.
	S 6-5-2-5	1.3243	Milling cutters, twist drills and taps.
	S 7-4-2-5	1.3246	Milling cutters, twist drills, taps, mould steels.
	S 10-4-3-10	1.3207	Turning tools and mould steels.
	S 12-1-4-5	1.3202	Turning tools and mould steels.
	S 18-1-2-5	1.3255	Turning tools, planing blades and milling cutters.
	S 2-10-1-8	1.3247	Shaft type milling cutters.

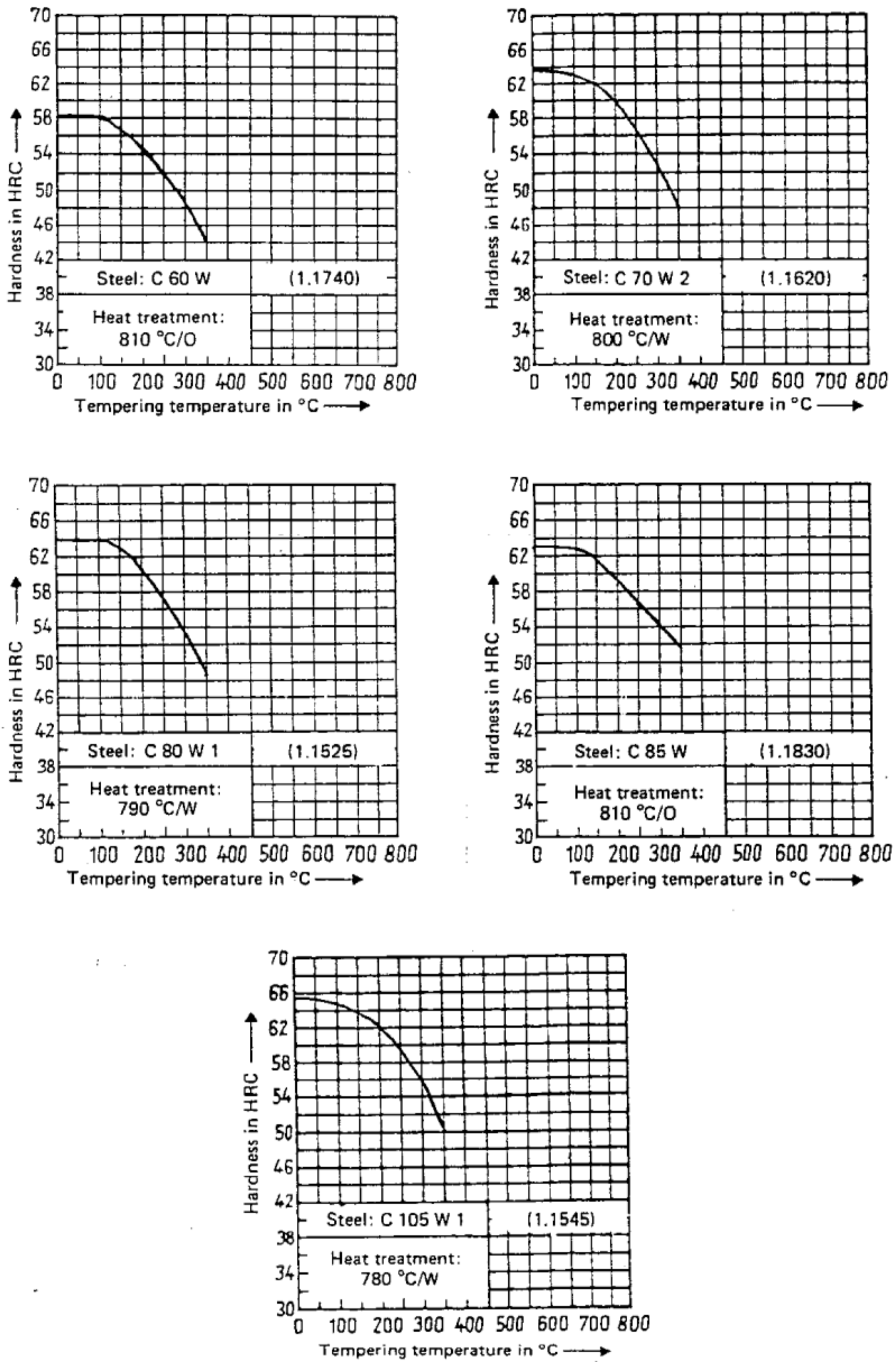

Figure 1. Hardness/tempering-temperature curves for unalloyed cold working steels in accordance with Table 2 \*)

\*) Quenching media O = oil, W = water



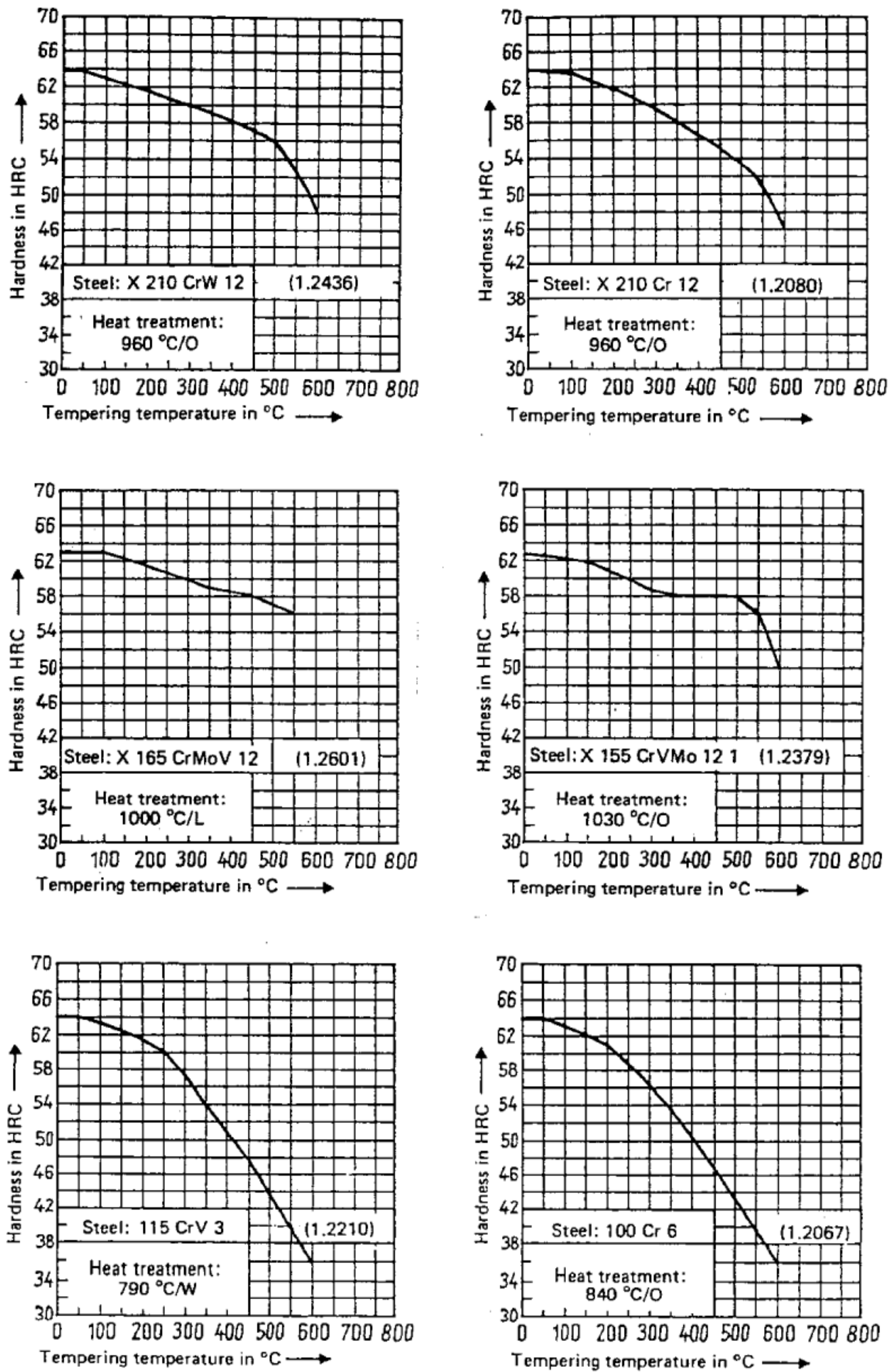

Figure 2. Hardness/tempering-temperature curves for cold working alloy steels in accordance with Table 3 \*)

\*) Quenching media O = oil, L = air, W = water

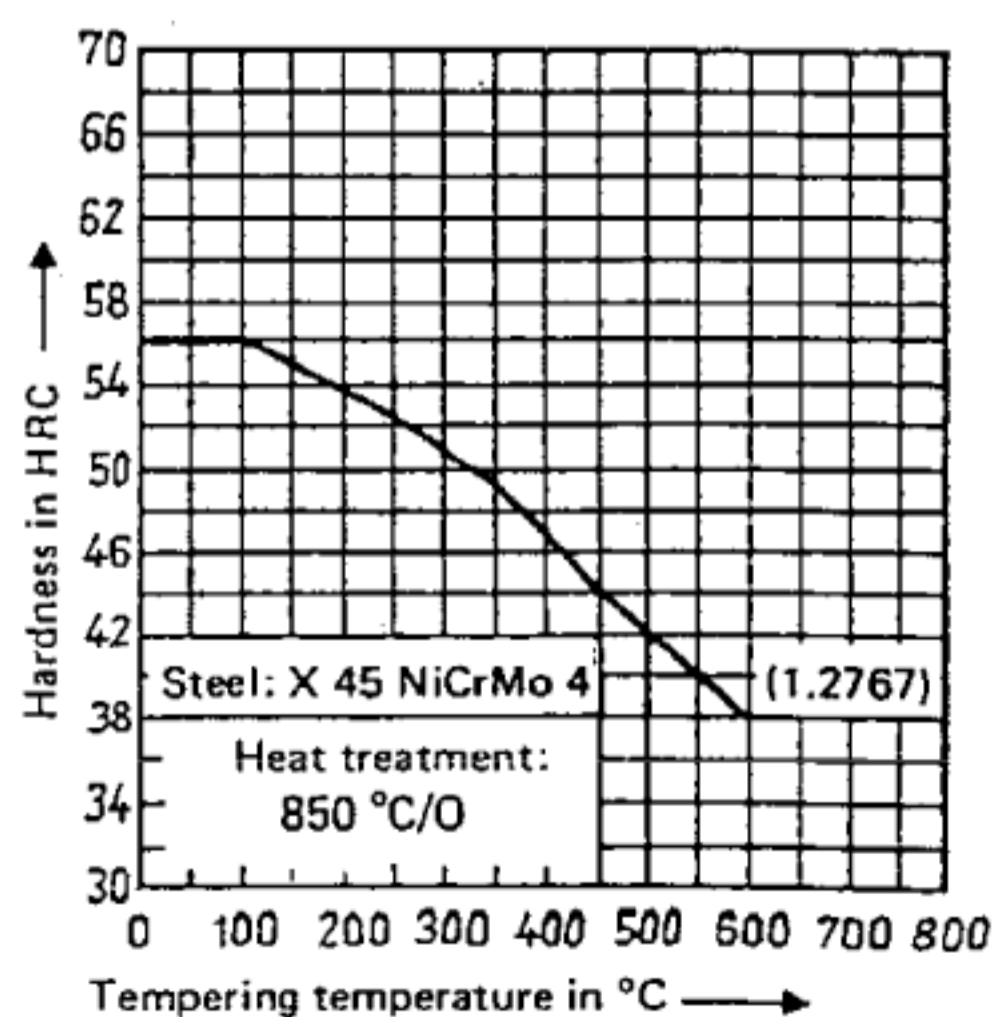
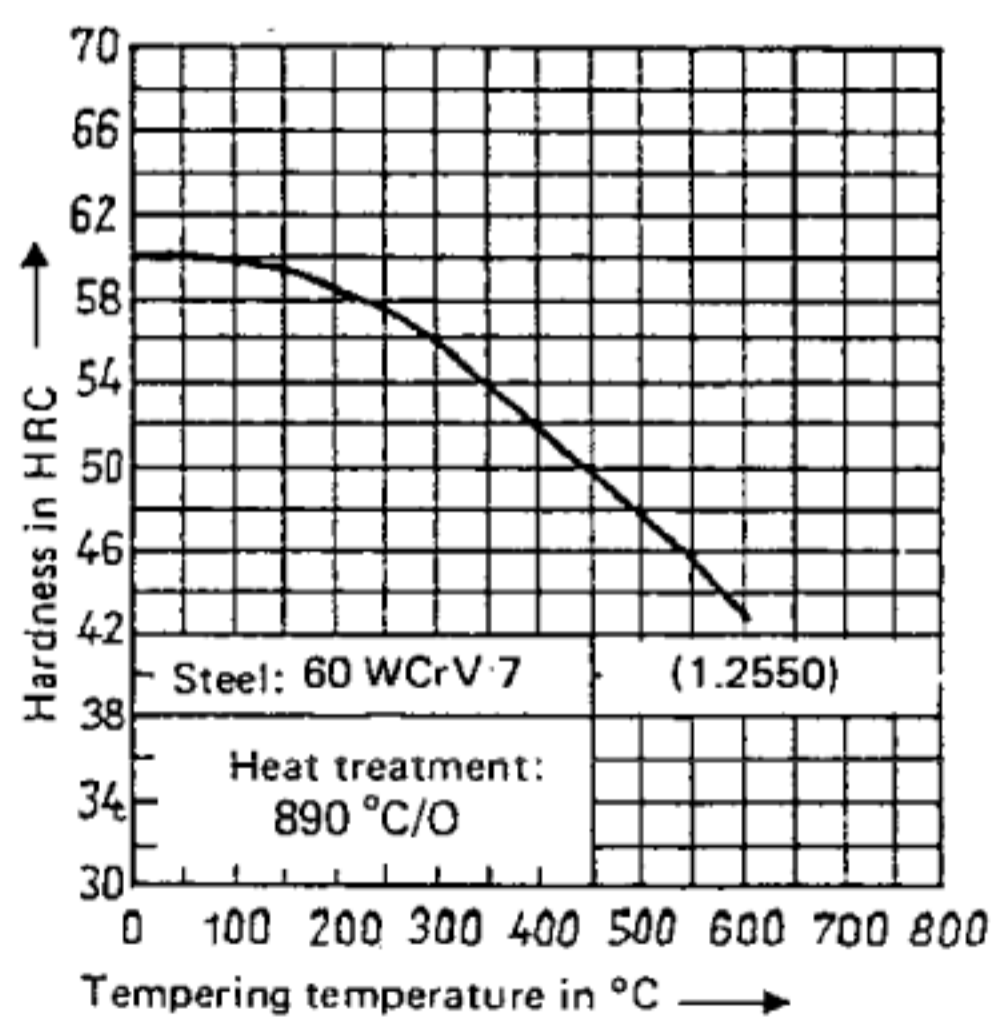
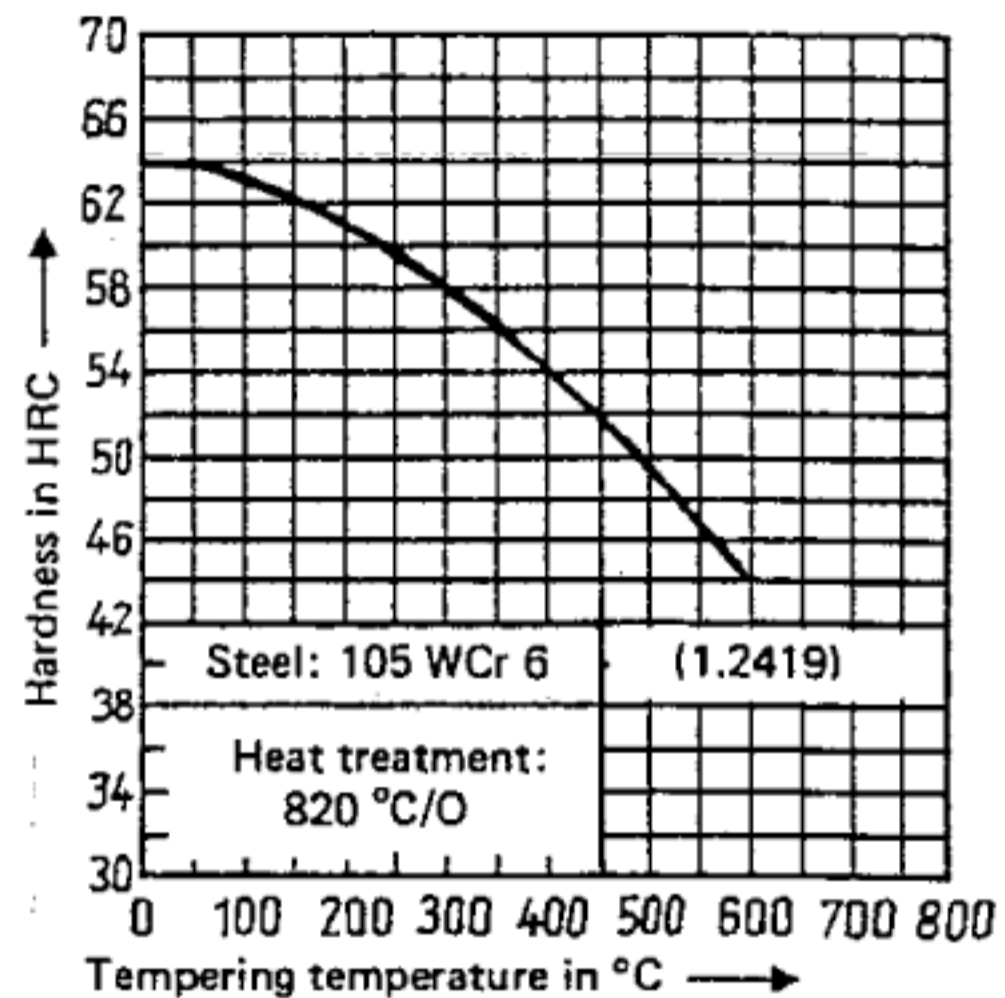
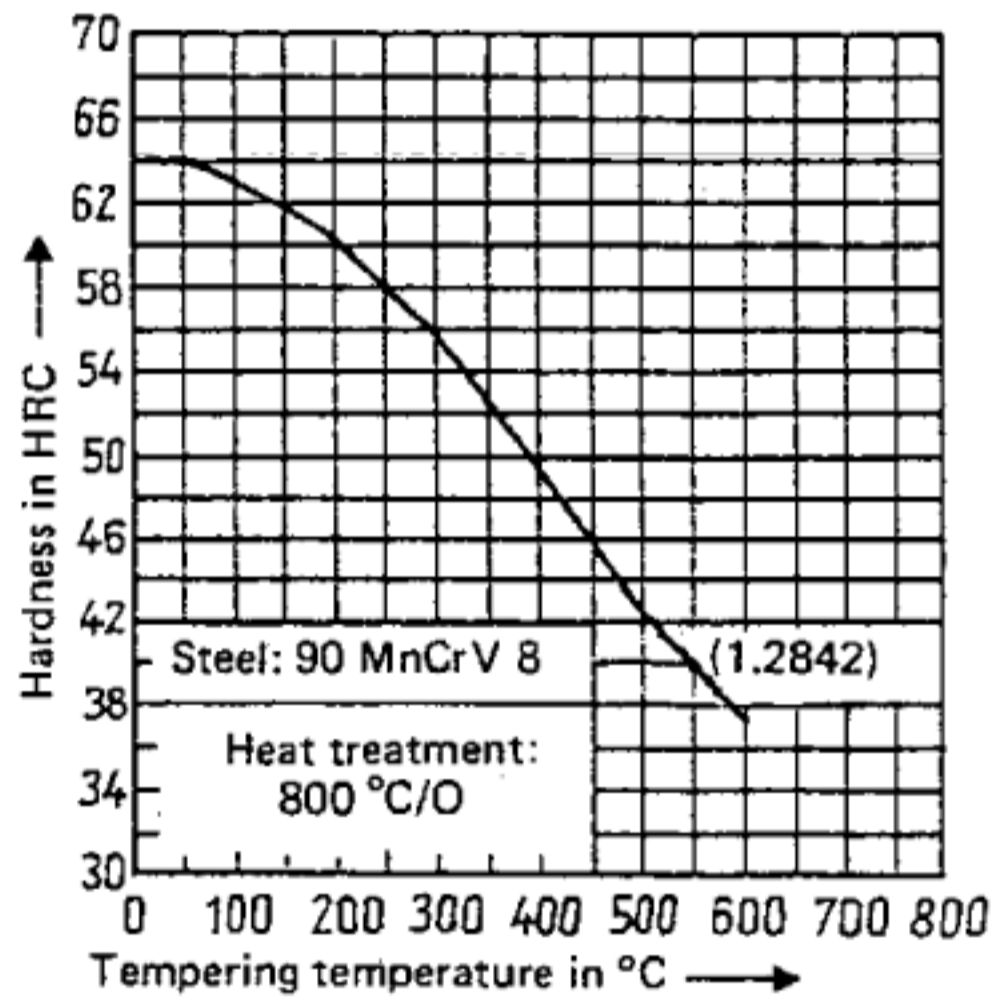
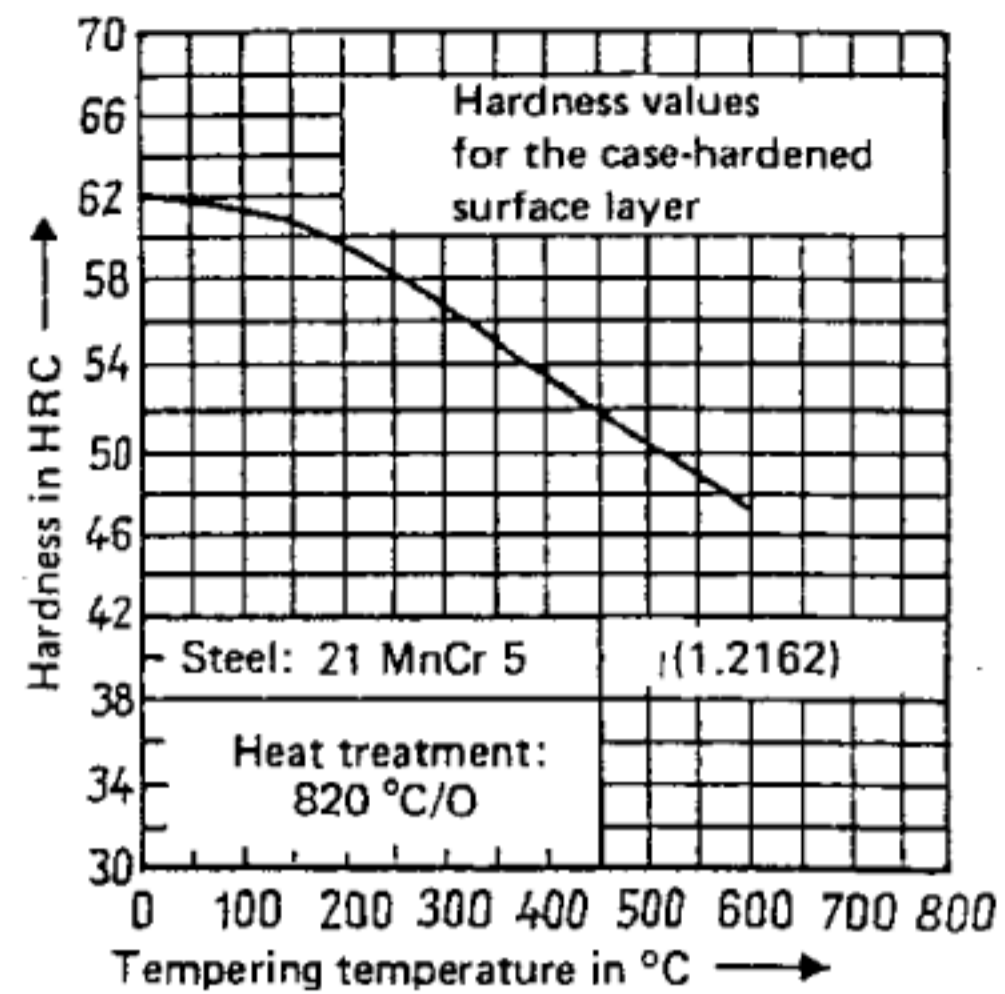
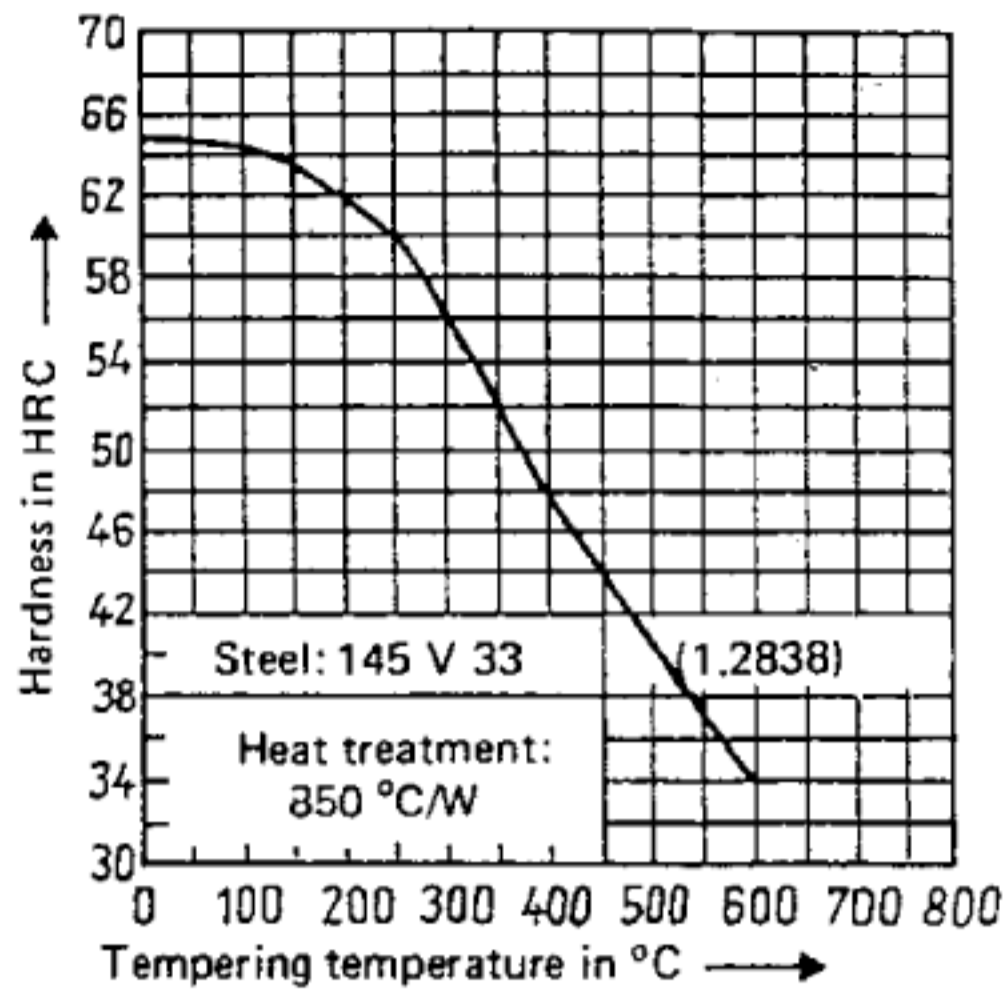

Figure 2. (Continued)



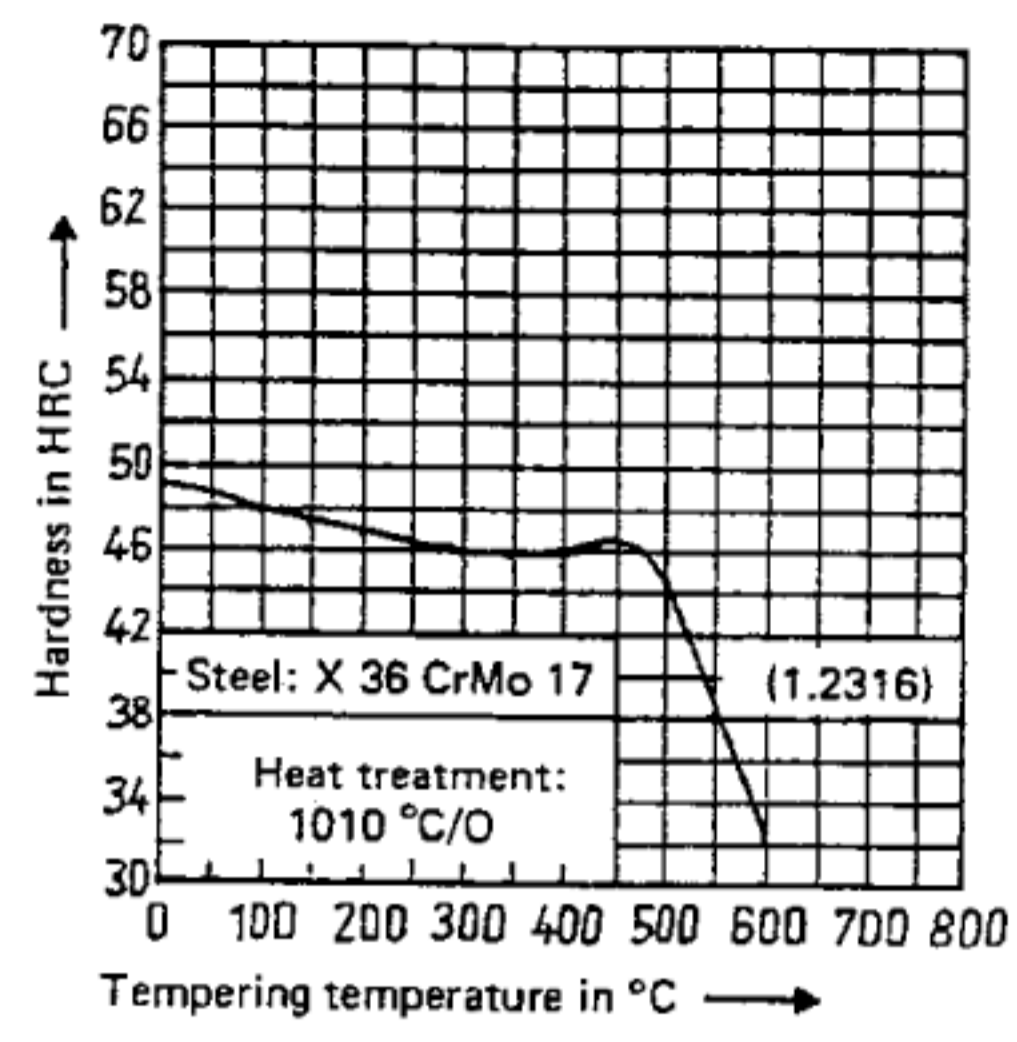
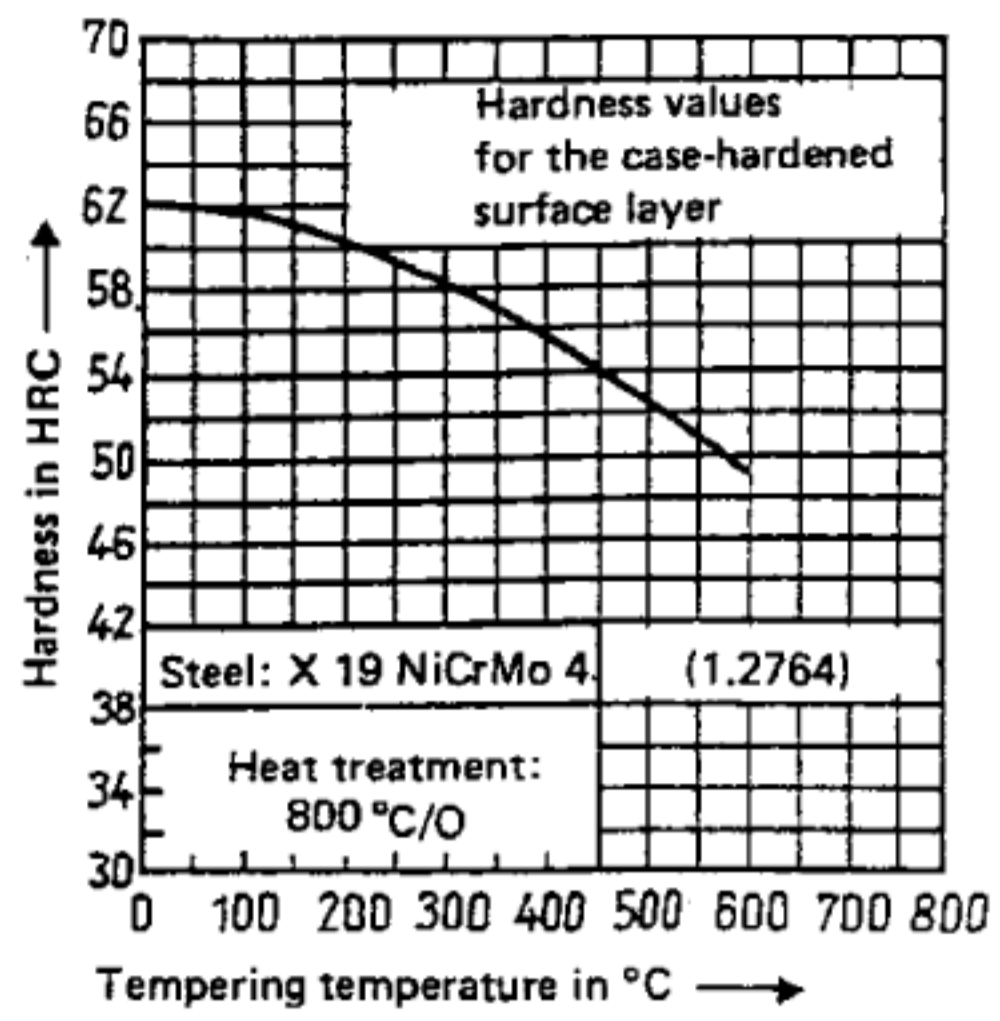

Figure 2. (Continued)

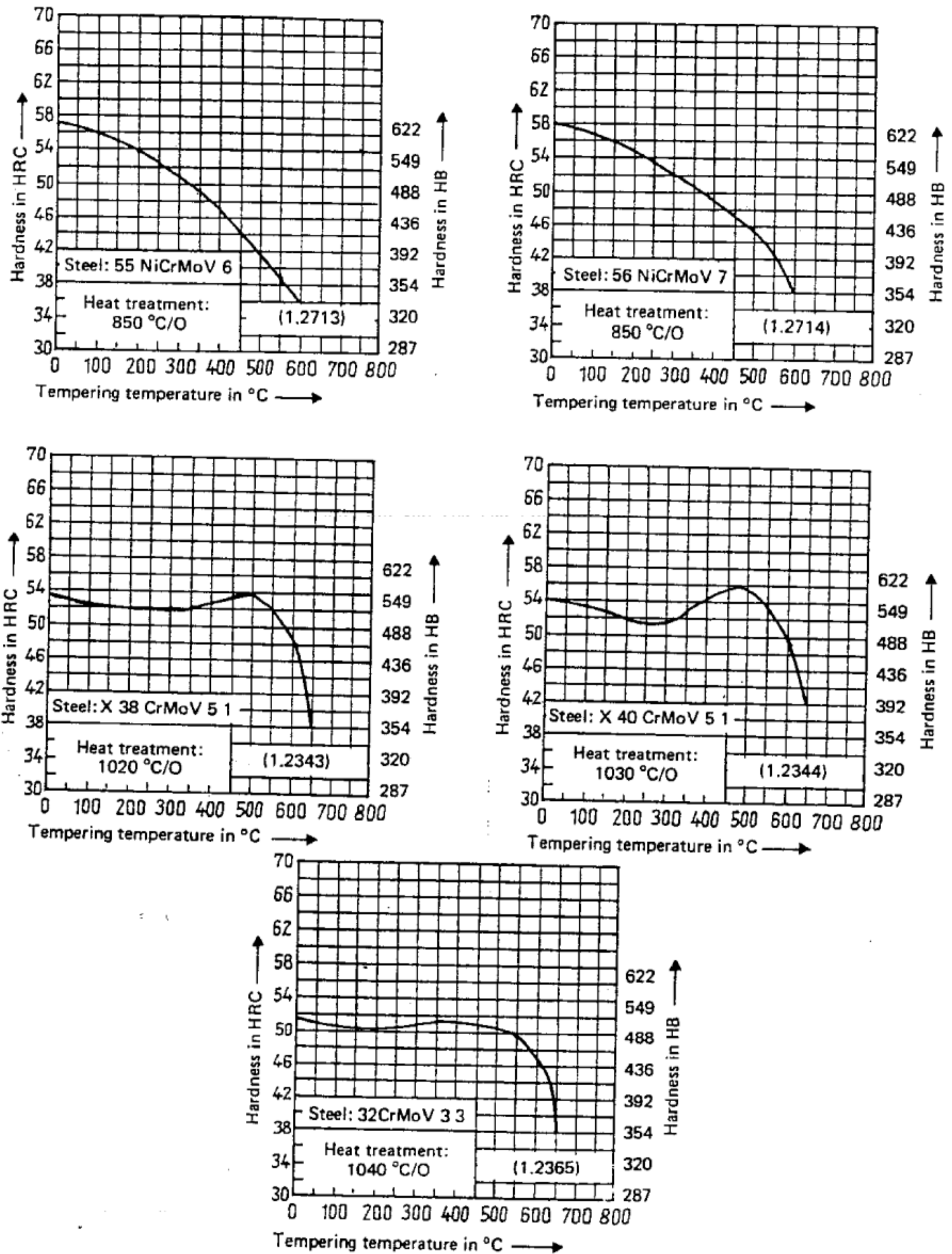

Figure 3. Hardness/tempering-temperature curves for hot working steels in accordance with Table 4 \*)  
 Note: The hardness values in HB shown on the right-hand Y-axis scale in each case refer to DIN 50 150, December 1976 edition, in the case of values up to 549 HB; the higher Brinell hardness values are not contained in these. The relationship to Rockwell hardness values has been determined by extrapolation. The conversion from HRC into HB refers to the Brinell hardness measurement with the hard metal ball.

\*) Quenching medium O = oil



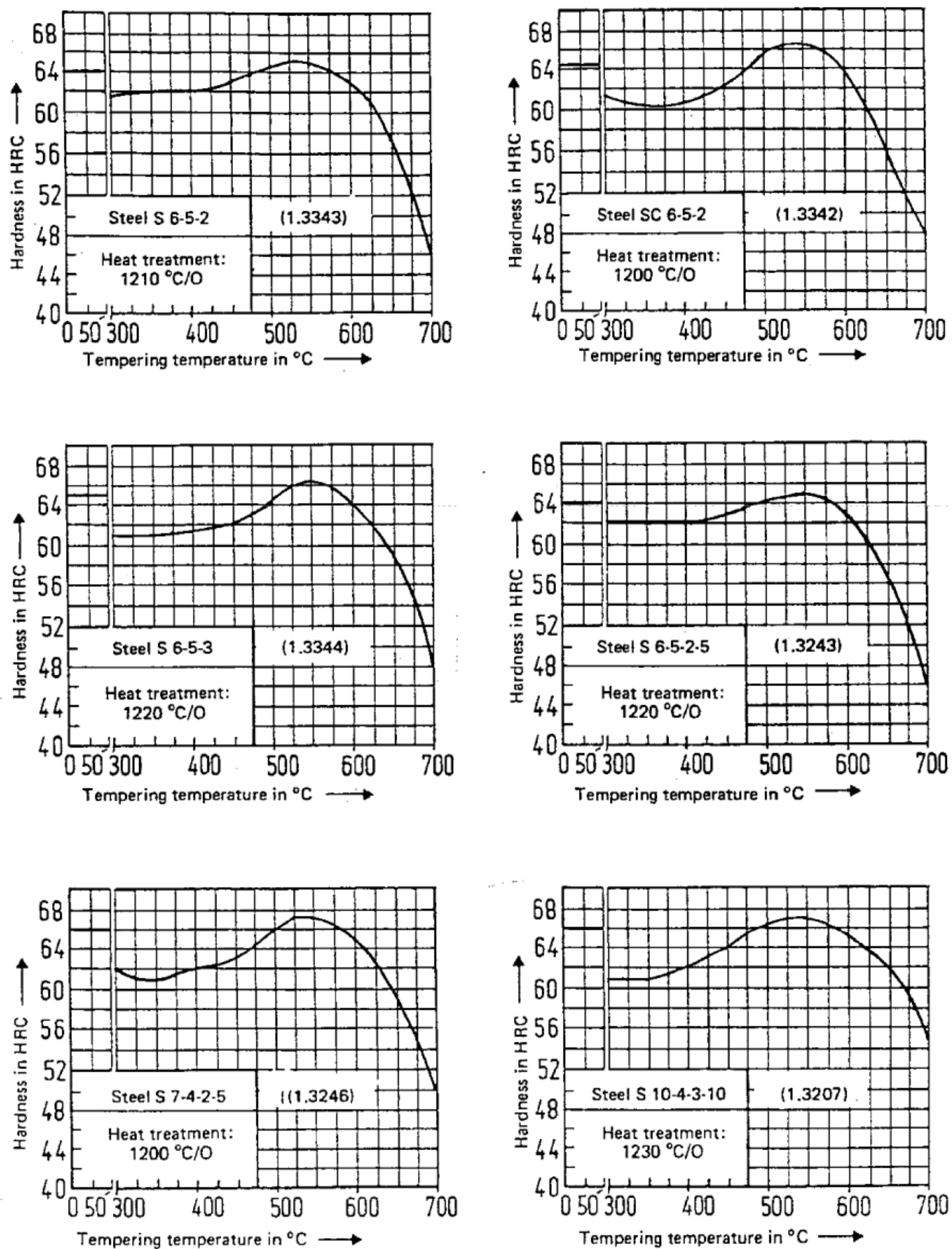

Figure 4. Hardness/tempering-temperature curves for high speed steels in accordance with Table 5 \*)

\*) Quenching medium O = oil

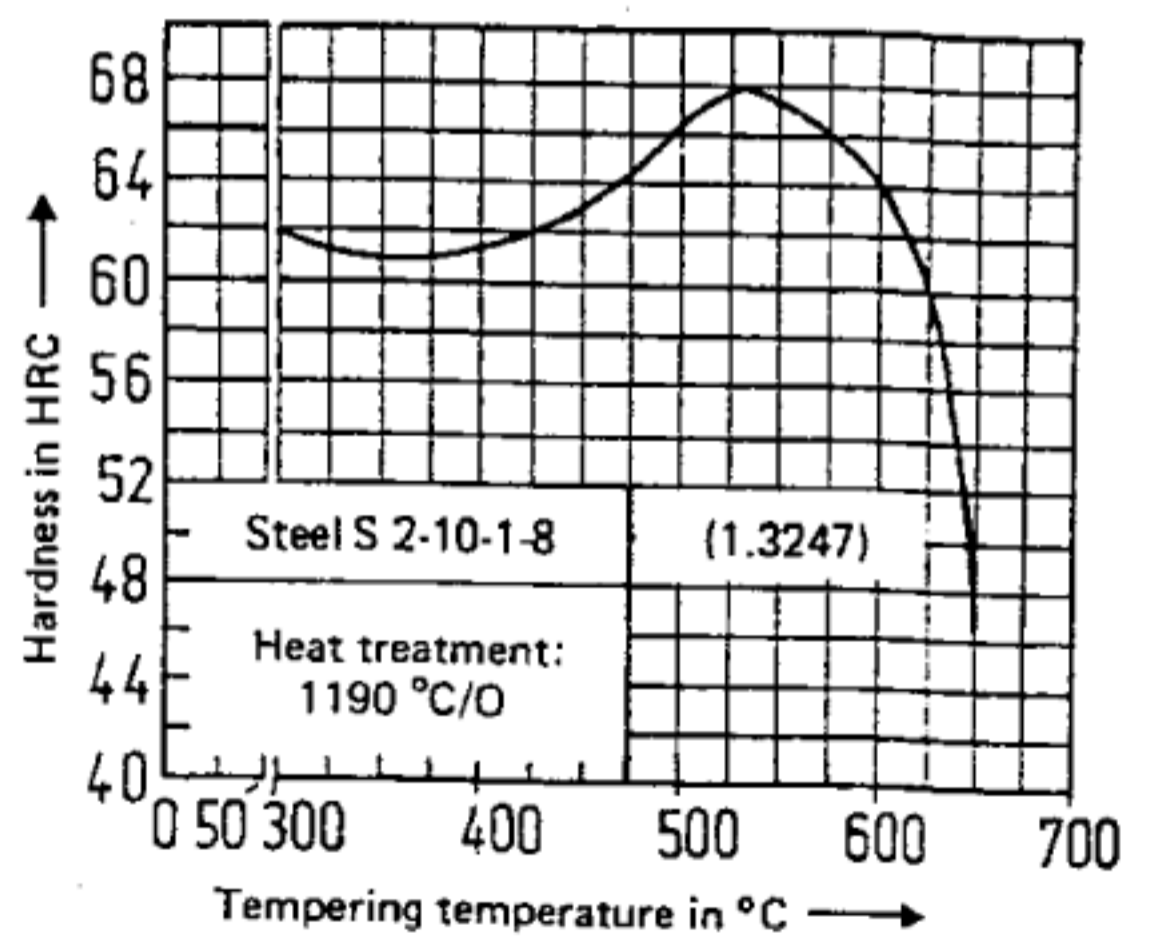
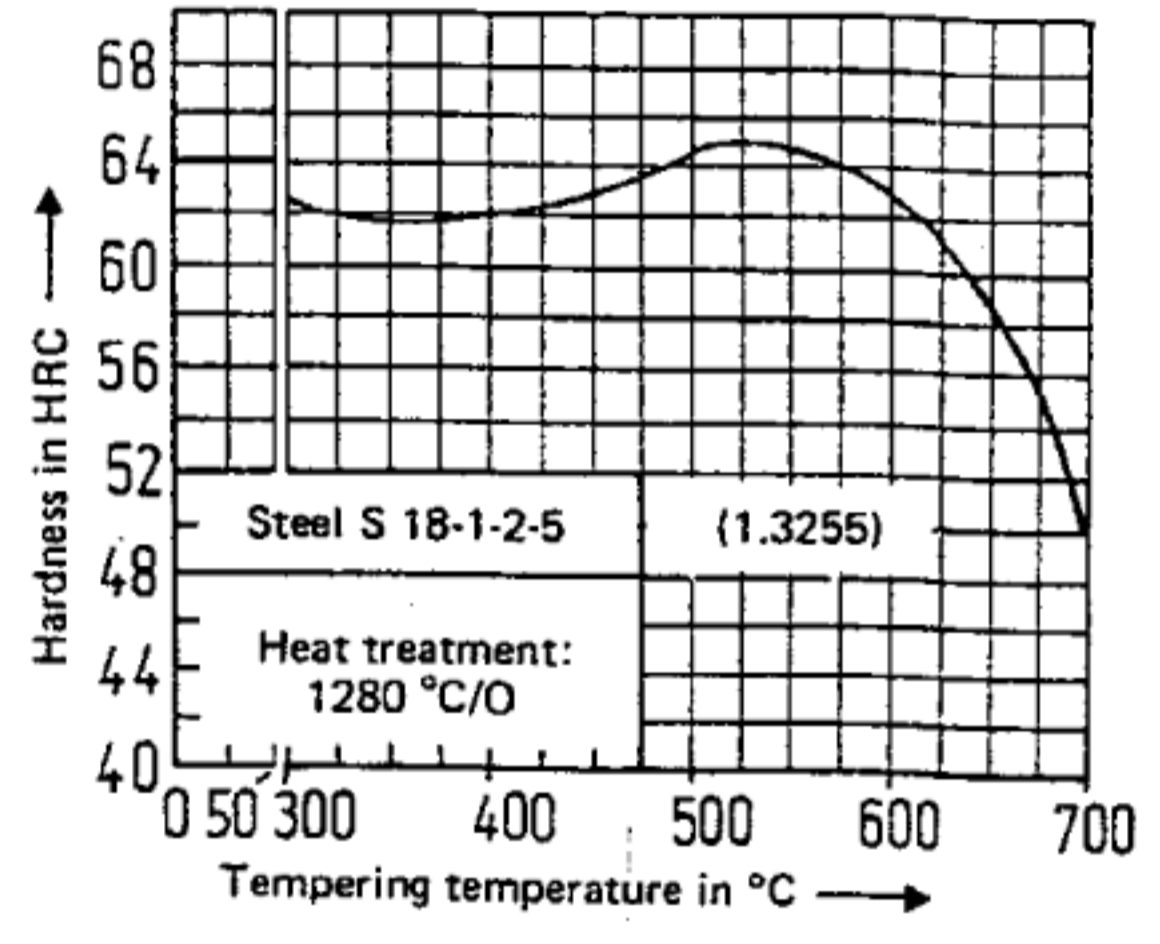
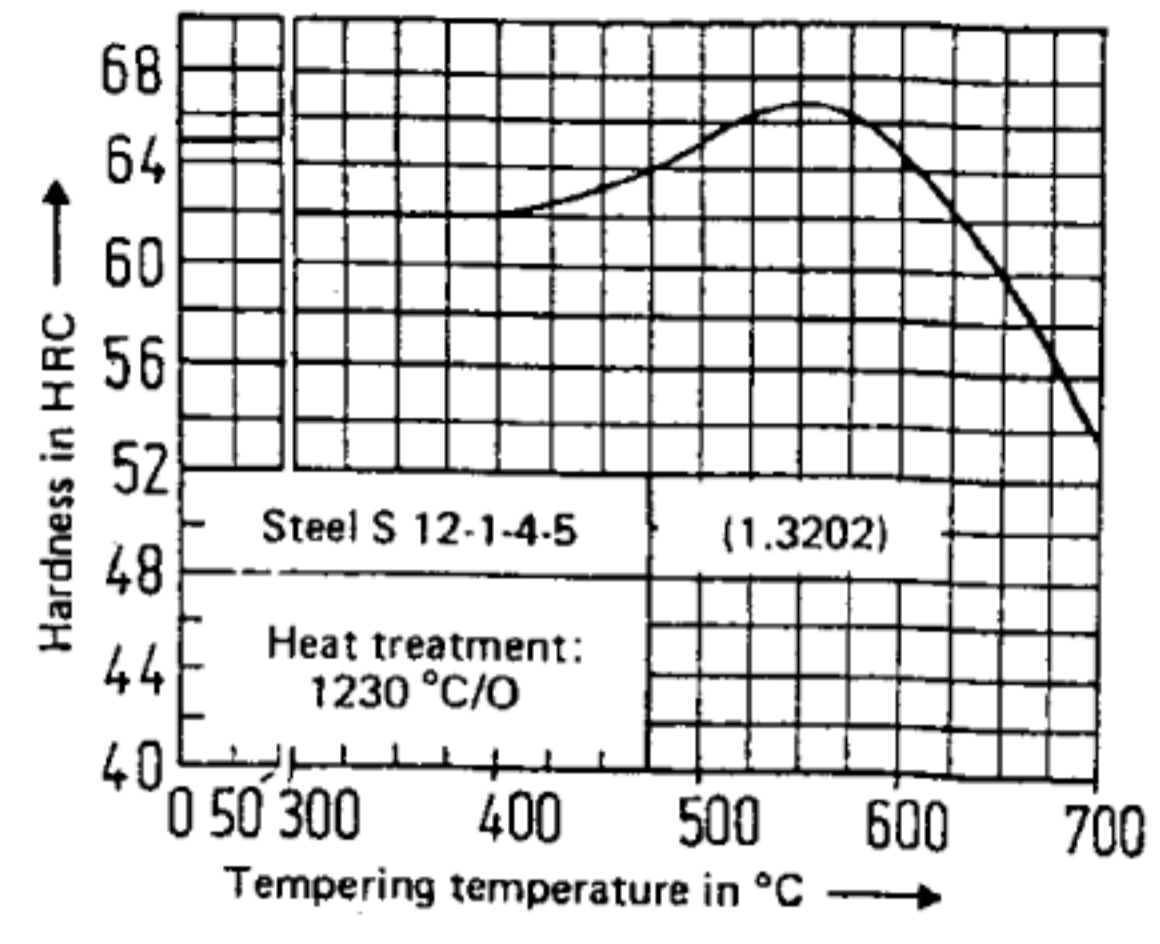
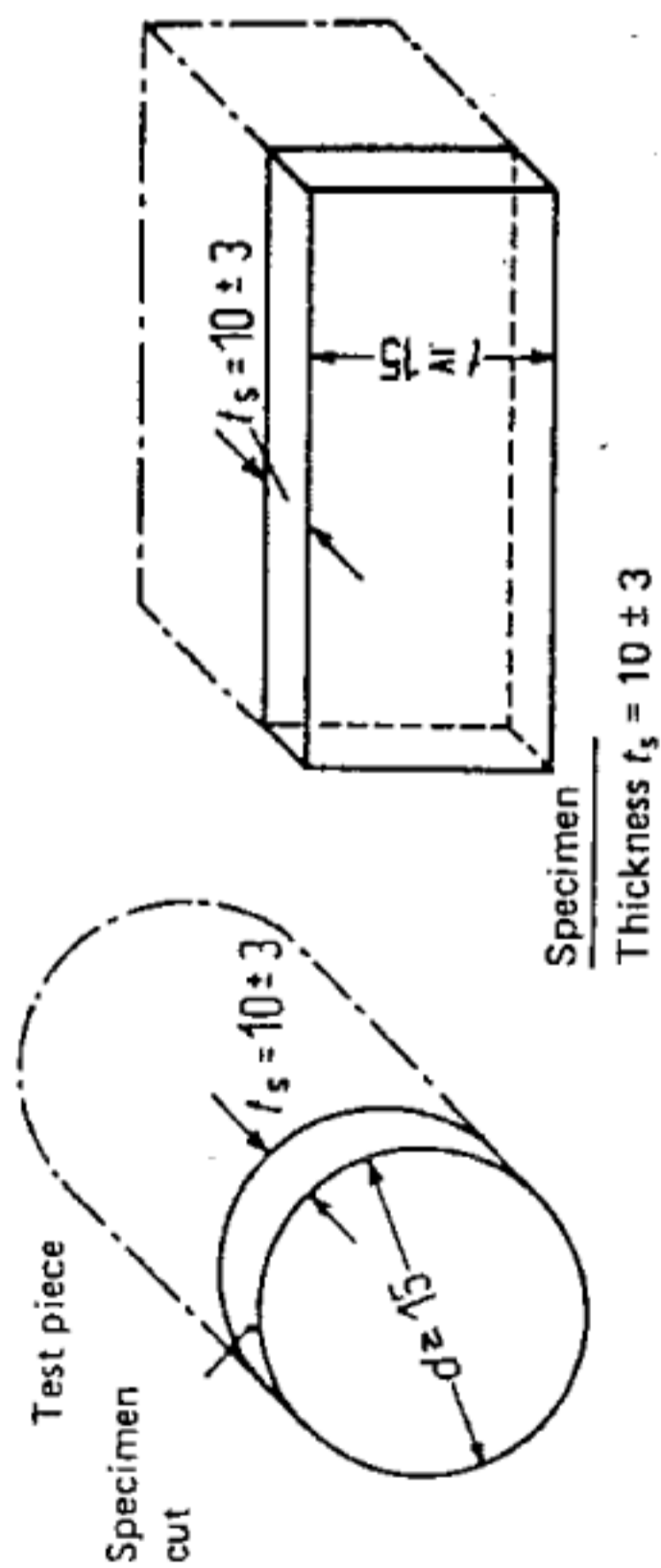
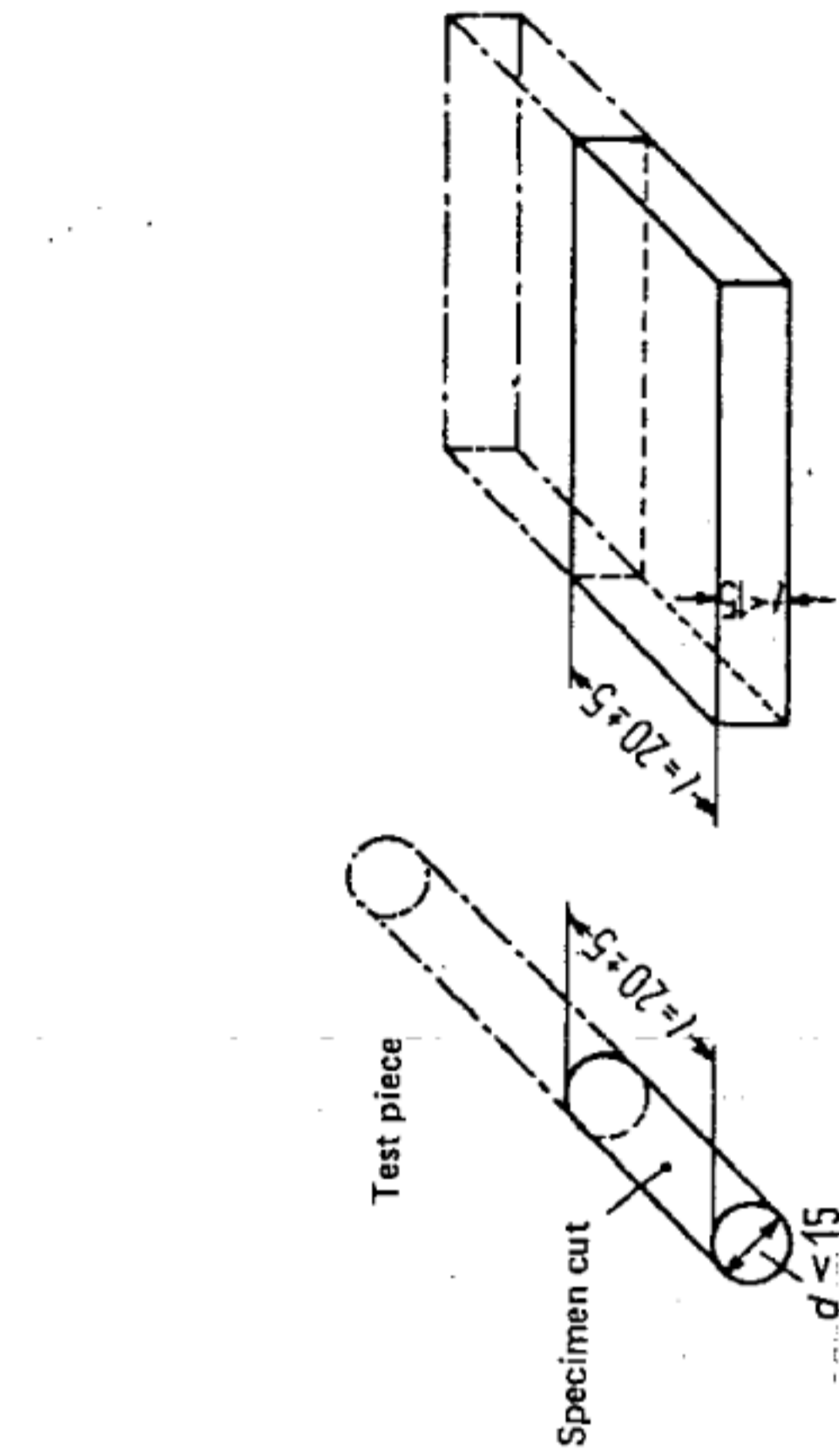

Figure 4. (Continued)



B) Product diameter or product thickness < 15

A) Product diameter or product thickness ≥ 15



At the discretion of the manufacturer the specimen is

a) either identical with the specimen cut

or

b) is obtained from the specimen cut by a further cut as shown below

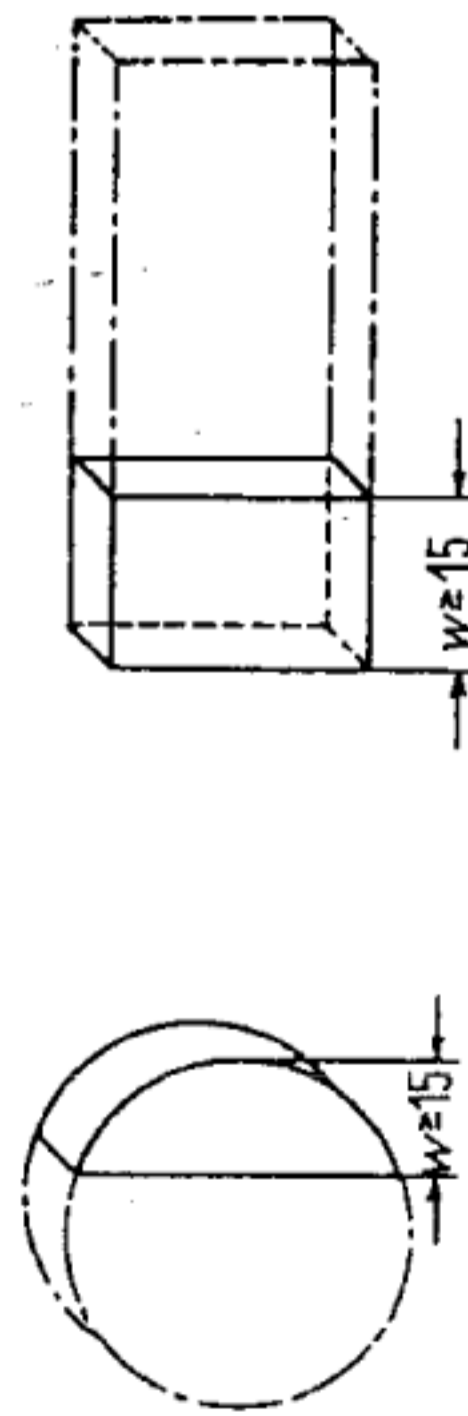

or

c) is obtained from the specimen cut by two further cuts as shown below

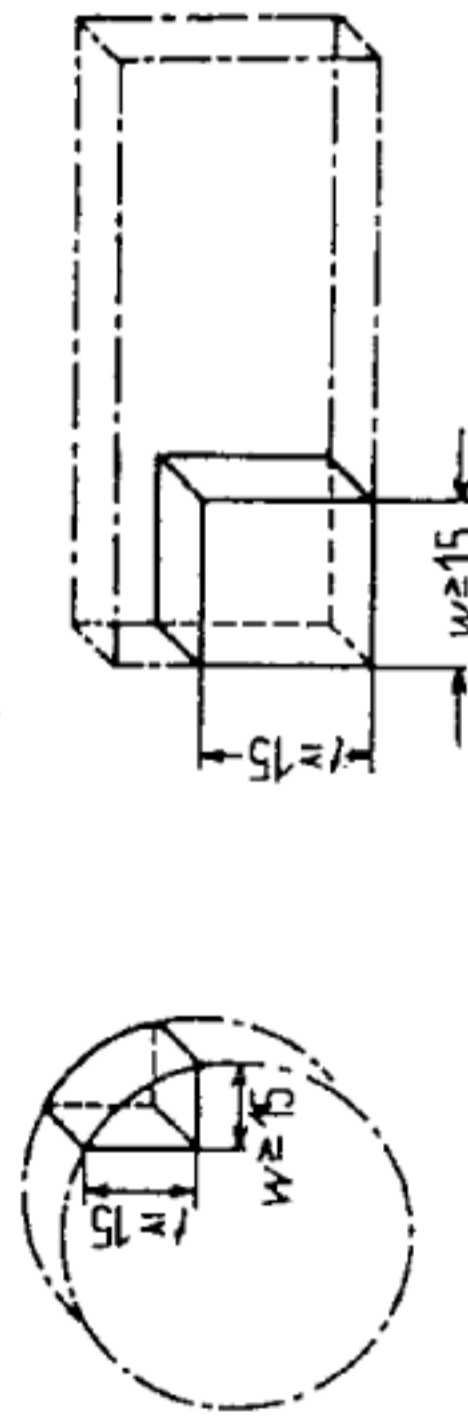

At the discretion of the manufacturer the specimen is

a) either identical with the specimen cut

or

b) is obtained from rectangular specimen cuts by a further cut as shown below

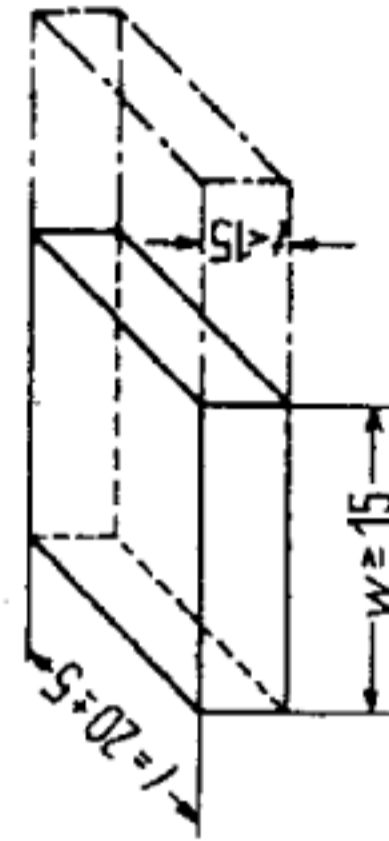

Figure 5. Position and dimensions of specimens for hardness testing in the tempered condition (dimensions in mm)

## Appendix A

Dimensional Standards <sup>4)</sup> relating to products made of tool steels in accordance with this Standard

DIN 174	Bright flat steel; dimensions, permissible variations, weights
DIN 175	Polished round steel; dimensions, permissible variations according to ISA tolerance zone h9, weights
DIN 176	Bright drawn hexagon steel; dimensions, permissible variations, weights
DIN 177	Steel wire, cold drawn; dimensions, permissible variations, weights
DIN 178	Bright square steel; dimensions, permissible variations, weights
DIN 668	Bright round steel; dimensions, permissible variations according to ISA tolerance zone h11, weights
DIN 670	Bright round steel; dimensions, permissible variations according to ISA tolerance zone h8, weights
DIN 671	Bright round steel; dimensions, permissible variations to ISA tolerance zone h9, weights
DIN 1013 Part 1	Steel bars; hot rolled round steel for general purposes; dimensions, permissible variations for dimension and form
DIN 1013 Part 2	Steel bars; hot rolled round steel for special purposes; dimensions, permissible variations for dimension and form
DIN 1014 Part 1	Steel bars; hot rolled squares for general purpose; dimensions, permissible deviations on dimensions and form
DIN 1014 Part 2	Steel bars; hot rolled squares for special purpose; dimensions, permissible deviations on dimensions and form
DIN 1015	Steel bars; hot rolled hexagon steel; dimensions, weights, permissible variations
DIN 1016	Flat products of steel; hot rolled strip, hot rolled sheet under 3 mm thickness; dimensions, permissible variations on dimension, form and weight
DIN 1017 Part 1	(at present still in draft form) Steel bars; hot rolled flat steel for general purpose, dimensions, permissible deviations on dimension and form
DIN 1017 Part 2	Steel bars; hot rolled flat steel for special purpose, dimensions, weights, permissible deviations
DIN 1541	Flat steel products; cold rolled wide mill strip and sheet of unalloyed steels; dimensions, permissible variations on dimension and form
DIN 1543	(at present still in draft form) Flat steel products; hot rolled sheet and plate from 3 to 150 mm thickness, permissible deviations on dimension, weight and form
DIN 1544	Flat steel products; cold rolled steel strip; dimensions, permissible variations on dimensions and form
DIN 7527 Part 1	Steel forgings; machining allowances and permissible variations for open-die forged discs
DIN 7527 Part 2	Steel forgings; machining allowances and permissible variations for open-die forged pierced discs
DIN 7527 Part 3	Steel forgings; machining allowances and permissible variations for seamless open-die forged rings
DIN 7527 Part 4	Steel forgings; machining allowances and permissible variations for seamless open-die forged bushes
DIN 7527 Part 5	Steel forgings; machining allowances and permissible variations for open-die forged rolled and welded rings
DIN 7527 Part 6	Steel forgings; machining allowances and permissible variations for open-die forged bars
DIN 59 110	Steel wire rod; dimensions, permissible variations, weights

<sup>4)</sup> See Section 4.



**Further Standards and documents**

- DIN 1599 Identification markings for steel  
 DIN 17 007 Part 2 Material numbers; system of the principal Group 1; steel  
 DIN 50 150 Testing of steel and cast steel; conversion table for Vickers hardness, Brinell hardness, Rockwell hardness and tensile strength  
 DIN-Normenheft 3 Code numbers and material numbers for ferrous metals in DIN Standards and Stahl-Eisen-Werkstoffblättern  
 EURONORM 96 Tool steels; quality requirements  
 See also Section 1.3.

**Explanations**

This Standard derives from the following Stahl-Eisen-Werkstoffblätter<sup>1)</sup> issued by the Verein Deutscher Eisenhüttenleute

- 150 – 71 Unalloyed tool steels
- 200 – 69 Cold working alloy steels
- 250 – 70 Hot working steels
- 320 – 69 High speed steels

At the start of the discussions, users proposed a division of the Standard into three special parts for

- a) unalloyed tool steels,
- b) alloy tool steels (i.e. bringing together both cold working alloy steels and hot working steels),
- c) high speed steels

to facilitate a revision. To reduce the size of the Standard, it was intended to omit the explanations for heat treatment and, for example, the time/temperature transformation diagrams.

372

The manufacturers pointed out that, in line with regional and international standardization, incorporation of all these steels in one Standard would be more desirable, especially since the same specifications applied to many steels and there was increasing overlapping of applications; also, in the case of a sub-division on the basis of material groups, in practice the only differences would be differences in the scope and in the description of the structural conditions.

Agreement was reached that the Standard should be left in one part. Additional notes on heat treatment including time/temperature-transformation diagrams and also approximate data for the effect of the workpiece diameter on the core hardness and the hardness penetration depth of

<sup>1)</sup> Verlag Stahleisen mbH, D-4000 Düsseldorf 1

cold working alloy steels and for the dependence of the mechanical properties on the test temperature in the case of hot working steels have been given in a Supplement.

This Standard is related to Euronorm 96 – Tool steels; quality requirements – issued by the European Coal and Steel Community (ECSC) and Draft International Standard ISO/DIS 4957 “Tool steels” issued by the International Organization for Standardization (ISO).

For a comparison of the standard specifications contained in the international documents with those in this Standard reference should be made to the comparative table at the end of these Explanations.

Apart from this, the following differences should be noted:

- a) EU 96 and ISO/DIS 4957 do not contain any descriptions of structural conditions or any supplementary data on heat treatment etc. as contained in the Supplement to this Standard.
- b) Steels according to this Standard, in contrast to those in EU 96 and ISO/DIS 4957 cannot be ordered by requirement classes.
- c) EU 96 contains information on minimum machining allowances for steel bars of circular, hexagonal or octagonal cross-section.
- d) This Standard contains additional grades of steel in Table 7 that are used almost exclusively for a single purpose; for these steels, only the chemical composition and the main application is specified.
- e) This Standard contains in Table 8 information on the main applications of the steels in accordance with Tables 2, 3, 4 and 5.

Of the points arising during the discussions on this Standard, including those relating to its revision, the following points require mention:

1. It will be necessary to check whether the cold working alloy steels X 210 Cr 12 (1.2080) and X 165 CrMoV 12 (1.2601) in Table 3 will have to be retained, since interchangeable steels have already been standardized on the application side in the form of the steels X 210 CrW 12 (1.2436) and X 155 CrVMo 12 1 (1.2379); the steel X 155 CrVMo 12 1 (1.2379) from the point of view of application offers more possibilities than the comparable steel X 165 CrMoV 12 (1.2601). Users drew attention to the fact that the high hardening temperature for the steel X 155 CrVMo 12 1 (1.2379), which was necessary in order to exploit the high secondary hardness and the possibility of salt-bath nitriding, could not be achieved in all workshops.

The steel 50 NiCr 13 (1.2721) which had been provided with higher toughness properties because of its added nickel and hence had been used for nuts and bolts and blanks for manufacture of milling cutters was not included because a technical alternative is already available with the grade X 45 NiCrMo 4 (1.2767).

The steel X 210 CrCoW 12 (1.2884) which was intended to provide better resistance to wear because of the cobalt addition was not adopted, because the quantities of this steel used are insignificant and some users do not regard it as any longer necessary.

Even the steel 145 Cr 6 (1.2063) originally used as a cutting steel and which the users suggested could now

be used for clamping mandrels was not included since it can only be manufactured with difficulty because of its tendency to form grain boundary carbides and hence the quantity produced is constantly falling.

2. The tungsten alloy steels which the users expressed a desire to include among the hot working steels (Table 4) were not adopted because these steels are only used for special purposes and in any case are being ousted by molybdenum alloy steels; besides they are produced only in insignificant quantities and some are also contained in EU 96 and ISO/DIS 4957.
3. Of the high speed steels listed in Table 5, steel S 2-10-1-ε (1.3247) has only been adopted on a provisional basis. The desire of the consumers for standardization of this steel was based on the grounds that it was technically necessary and, among other things offered an interesting range of performance because of its toughness properties. On the other hand, the manufacturers want to delete this steel because it accounts for less than 1 % of the total production of high speed steels (the other high speed steels in Table 5 account for 75 % of the production) and from the point of view of application is comparable with the steel S 7-4-2-5 (1.3246) also listed in Table 5. The high speed steel S 2-9-2 (1.3348) in Table 7 was also only adopted on a provisional basis. This steel is very similar to the high speed steel S 6-5-2 (1.3343) in Table 5 in its range of application so that there is no technical necessity to standardize it; however, from an economic point of view (price of tungsten, price of molybdenum) it may be of some significance. For reasons of rationalization the manufacturers want this steel also to be deleted.

The high speed steels S 2-9-2-8 (1.3249), S 12-1-4 (1.3302) and S 18-0-1 (1.3355) also proposed by users have not been included in this Standard because they overlap technically with the steels standardized in Table 5.

All interested parties are requested to give their comments on the question of inclusion of the five grades of high speed steel listed above in a subsequent edition of this Standard.

4. It is feasible that in a subsequent edition the wording of some sections might be deleted and replaced by references to DIN 17 010 – General technical conditions of delivery for steel and steel products.
5. It is intended to prepare a special Standard with classes of machining allowances for tool steels. In this context, it was stated that the term “machining allowance” here means the sum of depths of the defects, i.e. the addition to cover defects, whereas in DIN 7527 the term “machining allowance” there used means the allowance ordered, i.e. it is equivalent to the machining allowance as defined in this Standard plus half the minus tolerance. Three classes of machining allowances will be stipulated:
  - a) for black steel (similar to DIN 1013 and DIN 7527);
  - b) for roughly premachined material;
  - c) for material free of defects.

Since there was agreement that this was a qualitative and not a dimensional factor, it is intended to include the stipulations for the classes of machining allowances in the subsequent edition of DIN 17 350.